SQM-LU-DL-V OPERATOR'S MANUAL



© Copyright 2005 - 2026
Version: 20260307

Company information

Mailing address	Unihedron 4 Lawrence Avenue Grimsby, Ontario L3M 2L9 Canada
Telephone	(905) 945-1197
Website	unihedron.com

Contents

List of Figures	5
List of Tables	6
1 Introduction	9
1.1 QuickStart	9
1.1.1 Setting up the instrument	9
1.1.2 Saving the data log	10
1.1.3 Getting the data from the data log into MS Excel	10
1.1.4 Other software	10
1.1.5 FITS integration	10
2 Measurements	11
2.1 Getting accurate readings	12
2.1.1 Seeing conditions	12
2.1.2 Light pollution	12
2.1.3 Other luminance scales	13
3 Theory of operation	15
3.1 Light measurement	15
3.2 Communication to the PC	16
4 Specifications	17
5 Hardware connections	20
5.1 Battery operation	20
5.1.1 Battery performance	22
5.1.2 Solar charger	22
5.2 Diagnostic LED	23
6 Software development	24
6.1 Writing your own software interface	24
6.2 Pascal	25
7 Unihedron Device Manager	26
7.1 Getting UDM	26
7.2 Installation	26
7.2.1 System requirements	26
7.2.2 Windows	26
7.2.3 Mac	26
7.2.4 Linux	26
7.3 Operation	27
7.3.1 Start up	27
7.3.2 Main screen	27
7.3.3 Main menu	28

7.3.4	File menu	28
7.3.5	View menu	29
7.3.6	Tools menu	36
7.3.7	Help menu	49
7.4	Information tab	50
7.5	Log Continuous	51
7.5.1	Import.dat into spreadsheet	59
7.6	Calibration tab	60
7.7	Report Interval tab	61
7.7.1	Continuous reports	61
7.8	Firmware tab	62
7.9	Data Logging tab	64
7.10	Configuration tab	70
7.10.1	Sensor arrangement	70
7.11	Simulation tab	71
7.11.1	Simulation from file	71
7.11.2	Test response	72
7.12	Accessory options	73
7.12.1	Humidity accessory	73
7.12.2	Display accessory	73
7.12.3	LED accessory	73
7.12.4	Relay accessory	73
7.13	Command line parameters	74
7.13.1	Internal startup options	75
7.13.2	Windows autostartup	75
7.13.3	Windows scheduled startup	75
7.13.4	Mac autostartup	76
8	Commands and responses	77
8.1	Commands	77
8.2	Response details	79
8.2.1	Reading request	79
8.2.2	Unaveraged reading request	81
8.2.3	Linear reading request	82
8.2.4	Inline linear reading request	83
8.2.5	Unit information	83
8.3	Calibration commands	84
8.3.1	Calibration information request	84
8.3.2	Light calibration command	85
8.3.3	Dark calibration command	85
8.3.4	Disarm calibration command	86
8.3.5	Manually set light calibration offset	86
8.3.6	Manually set light calibration temperature	87
8.3.7	Manually set dark calibration time period	87
8.3.8	Manually set dark calibration temperature	87
8.4	Snow LED accessory	88
8.5	Datalogger commands	90
8.5.1	FLASH ID report	90
8.5.2	Logging pointer report	90
8.5.3	Logging capacity report	91
8.5.4	Erase entire FLASH memory	91
8.5.5	Log one record	91
8.5.6	Return one logged record	91
8.5.7	Retrieve all Binary	93

8.5.8	Get internal voltage	95
8.5.9	Get EEPROM status register 1	95
8.5.10	Set and read logging trigger mode	95
8.5.11	Logging Interval setting response	96
8.5.12	Logging interval reporting period setting	97
8.5.13	Logging threshold setting for interval reporting	97
8.5.14	Set and read logging Real Time Clock	97
8.5.15	Get Real Time Clock version	98
8.5.16	Put datalogging unit to sleep	98
8.5.17	Gather alarm 0 data from RTC	98
8.5.18	Mutual access	99
8.6	Accessories commands	100
8.6.1	Humidity / Temperture sensor	100
8.6.2	Display accessory	101
8.6.3	LED accessory	102
8.6.4	Relay accessory	103
8.7	Continuous reporting commands	104
8.8	Setting Interval reporting parameters	106
8.8.1	Interval reporting period setting	106
8.8.2	Threshold setting for interval reporting	106
8.8.3	Interval setting response	107
8.9	Simulation commands	108
9	Installation	110
9.1	Mechanical installation	110
9.1.1	Cover selection	110
9.1.2	Cover calibration	110
9.1.3	Cover maintenance	111
10	Default settings	112
11	Firmware upgrade	113
11.1	Details	113
12	Calibration	114
12.1	Recalibration	114
12.2	Light calibration	114
12.3	Dark calibration	114
12.4	Confirmation	114
13	Troubleshooting	115
14	Glossary	120
15	Bibliography	121

List of Figures

2.1	Mpsas interpretive scale	11
2.2	Mpsas vs NELM	14
3.1	SQM-LU-DL Block diagram	15
4.1	Front and back of unit	19
5.1	Wired connection	20
5.2	Battery connection	20
5.3	Current profile	21
5.4	Battery discharge plot	23
5.5	Diagnostic LED timing diagram	23
7.1	Splash screen	27
7.2	File menu	28
7.3	File Open dialog	29
7.4	View menu	29
7.5	View : Log	30
7.6	View:Directories	30
7.7	Data logging header	32
7.8	Set Location dialog	33
7.9	Plotter window	34
7.10	Tool : old log to dat	36
7.11	Tool : dat to Moon csv	36
7.12	Tool : Comm terminal	37
7.13	Tool : .dat to .kml	37
7.14	Tool : .dat to .kml GoogleEarth result	38
7.15	Tool : .dat time correction	38
7.16	Tool : .dat local time reconstruction	39
7.17	RSE algorithm	42
7.18	Filter tool data 1	46
7.19	Filter tool data 2	47
7.20	Filter tool data 3	48
7.21	Help menu	49
7.22	Help : About	49
7.23	Found device (single)	49
7.24	Found device (multiple)	50
7.25	USB connection details	50
7.26	Ethernet connection details	50
7.27	RS232 connection details	50
7.28	Information tab	51
7.29	Log Continuously screen	52
7.30	Log Continuously Trigger tab	52
7.31	Log Continuously Look tab	52
7.32	Log Continuously Status tab	53
7.33	Log Continuously Threshold	53
7.34	Log Continuously alerts	54
7.35	Log Continuously Alarm for darkness	54
7.36	Log Continuously Transfer reading	54

7.37	Log Continuously Transfer tab	55
7.38	Log Continuously Annotation tab	57
7.39	Log Continuously GPS tab	57
7.40	Calibration tab (initial)	60
7.41	Calibration tab (populated)	60
7.42	Report interval tab	61
7.43	Firmware tab	62
7.44	Firmware selection	62
7.45	Data logging tab	64
7.46	Data logging trigger selection	64
7.47	Data logging: Mutual access logging selection	65
7.48	Real Time Clock setting dialog	65
7.49	Storage navigation	65
7.50	DL Retrieve dialog window	67
7.51	DL Erase dialog window	69
7.52	Configuration tab	70
7.53	Light calibration confirmation	70
7.54	Dark calibration confirmation	70
7.55	Sensor arrangement	71
7.56	Fig:Simulation tab	71
7.57	Accessories tab	73
9.1	Housing	110
9.2	Example cover calibration	111

List of Tables

2.1	Apparent Magnitudes of Known Celestial Objects adapted from [2]	11
5.1	Battery performance	22
7.2	Default Logs Directory Path	31
7.3	Configfile path	31
7.4	.dat to Sun-Moon-MW-Clouds values	40
7.5	Storage navigation button descriptions	66
7.6	Extra definitions of retrieved fields	68
7.7	simin.csv field description	71
7.8	Log continuous command line parameters	74
7.9	Select device command line parameters	74
7.10	Select features command line parameters	74
8.1	Summary of standard commands	78
8.2	Summary of datalogger commands	79
8.3	rx Reading request response	79
8.4	r1x Reading request response	80
8.5	Unaveraged reading request response	81
8.6	Linear reading request response	82

8.7	Inline linear reading request response	83
8.8	Unit information request response	84
8.9	Calibration information request response	84
8.10	Light calibration response	85
8.11	Dark calibration response	85
8.12	Disarm calibration response	86
8.13	Response for manual setting of light calibration offset	86
8.14	Response for manually setting of light calibration temperature	87
8.15	Response of manually setting dark calibration time period	87
8.16	Response for manually setting of dark calibration temperature	88
8.17	Snow LED accessory command summary	88
8.18	Snow LED accessory response summary	88
8.19	Response of requesting the FLASH chip ID	90
8.20	Response of requesting the data logging pointer	90
8.21	Response of requesting the data logging capacity	91
8.22	Response of requesting to log one record	91
8.23	Request to return one logged record	92
8.24	Response to return one logged record	92
8.25	Response to Binary Retrieve command	93
8.26	Binary Retrieve record content	93
8.27	Response of requesting internal voltage	95
8.28	Response of requesting EEPROM Status register 1	95
8.29	Request to set the logging trigger mode	95
8.30	Response of setting or getting the log trigger mode	96
8.31	Response of viewing or setting logging interval reporting parameters	96
8.32	Setting the RTC	97
8.33	Response of getting the RTC values	97
8.34	Response of getting the RTC version	98
8.35	Response of getting the RTC “Alarm 0” value	98
8.36	Response of setting or getting the mutual access mode	99
8.37	Humidity/temperature command summary	100
8.38	Humidity/temperature response summary	100
8.39	Display accessory command summary	101
8.40	Display accessory response summary	101
8.41	LED accessory command summary	102
8.42	LED accessory response summary	102
8.43	Relay accessory command summary	103
8.44	Relay accessory response summary	103
8.45	Summary of standard commands	104
8.46	Continuous reporting command summary	104
8.47	Response of all continuous reporting requests	104
8.48	Interval report	106
8.49	Response of viewing or setting interval reporting parameters	107
8.50	Response of request for internal simulation values	108
8.51	Request simulation (S...x)	108
8.52	Response of setting simulation values (S...x)	109
13.1	Reading seem too bright	115
13.2	Reading is 0.00mpsas	115
13.3	Cannot Find UDM software	115
13.4	Driver not found	115
13.5	USB device not found, or more than one device on the same COM port	116
13.6	USB serial number garbled	116
13.7	LED does not light up	116

13.8	Recording stops	116
13.9	Meter cannot be found on battery or by PC	117
13.10	UDM improperly lists devices under Windows OS	117
13.11	Meter cannot be found by Windows operating system	118
13.12	Cannot get a reading	118
13.13	Darkroom-bag readings incorrect	119
13.14	UDM shuts down after starting	119
14.1	Glossary of terms	120

List of Equations

2.1	MPSAS to cd/m^2	13
2.2	NELM to MPSAS	14
2.3	MPSAS to NELM	14
8.1	Raw Temperature to degC	108
8.2	degC to Raw Temperature	108

1 Introduction

Thank you for purchasing the SQM-LU-DL-V. You will soon be on your way to collecting scientific data.

The SQM series of products have been used in the following applications:

- Quantitatively comparing the sky brightness at different astronomical observing sites.
- Documenting the evolution of light pollution.
- Setting planetarium dome illumination to mimic the skies that people are likely to experience elsewhere in the city.
- Monitoring sky brightness through the night, night-to-night, and year-to-year for astronomical observation records.
- Determining which nights show the greatest promise for finding the 'faintest fuzzies'.
- Calibrating the effect of sky brightness on qualitative measures such as the Bortle Scale or NELM.
- Investigating how sky brightness correlates with the solar cycle and month-to-month sunspot activity.
- Helping to provide local ground truth for future sky brightness prediction with the Clear Sky Clock.
- Helping CCD users make a correlation between the SQM reading and when the background reaches some ADC level.
- Assisting Sea Turtle researchers in studying the amounts of light in areas where turtle hatchlings are affected by artificial lights.
- Researching bird-song synchronization with dawn.
- Researching twilight brightness changes with the addition of external Neutral Density filters. Unihedron offers adapters to attach such filters onto the meter.
- The SQM-LU-DL-V has the same features as the SQM-LU with the addition of data logging and vector measurement capabilities.

The SQM-LU-DL-V appears identical to the SQM-LU-DL from the outside, the only identification is the paper label on the bottom of the unit, and the version identification from UDM.

1.1 QuickStart

1.1.1 Setting up the instrument

1. Connect the SQM-LU-DL-V meter to the computer with the supplied USB cable. Wait for any device drivers to automatically load (if required). You may have to visit www.FTDIchip.com to get the latest VCP drivers if they do not get installed automatically.
2. Ensure that your computer date and time is up-to-date.
3. Install and launch UDM (Unihedron Device Manager software supplied on the flash-drive from your File Manager).
4. Click the "Find" button in UDM to find attached devices, then click on the SQM-LU-DL-V that you connected.
5. Click the "Data Logging" tab to go to the setup page.
6. Click the "Settings" button in the "Device Clock" area on that page to access the synchronization page for the SQM-LU-DL-V .
7. You may have to wait about ten minutes for the internal supercapacitor to charge up. The Unit Clock will be counting up when the internal supercapacitor is charged up.
8. Click the "Set" button to set the unit clock to the current UTC time.

9. Next, set the repetition time for the readings in the “Trigger” section on the left side of the window. A good rate is “every 5 minutes”.
10. Keep the SQM-LU-DL-V connected to the computer for a couple of hours to charge up the internal Supercap; this allows it to keep the time and date clock running while you are moving from your computer to the measurement site. A fully charged meter will keep the clock running for a few days unpowered.
11. Disconnect the SQM-LU-DL-V from the USB cord and plug in the battery pack within eight hours, the LED will come on for three seconds to indicate that the unit woke up and is working. The LED will come on every minute for a few seconds, you can use this to determine if the unit is still properly powered. Note: beware that using a “USB charger” instead of the battery pack may cause problems since some of these chargers make the SQM-LU-DL-V think it is connected to a computer instead of a battery, and some other chargers do not have the surge capacity to allow the SQM-LU-DL-V to start up properly.

The device is now recording.

1.1.2 Saving the data log

Follow these steps to retrieve the logged data from the SQM-LU-DL-V:

1. Connect the SQM-LU-DL-V to the computer with the USB cable.
2. Launch the UDM program and find your device as before.
3. Select the “Data Logging” tab.
4. Click “Retrieve All” and follow the instructions on that page.
5. ONCE YOU’VE CHECKED THAT THE DATA IS SAVED TO DISK PROPERLY, and you want to clear the data-logger memory in preparation for a new set of records, you can erase the old memory. Warning this step cannot be undone!

1.1.3 Getting the data from the data log into MS Excel

1. Find the log data. It will be in a *.dat file, where the * will give you the date and time
2. In the Tools pulldown in the UDM program, use the “.dat to Moon .csv” function to convert the log file to a *.csv file. Do not erase the original log file, because it contains some information (e.g., the type and serial number of your SQM) that is not converted to the csv file.
3. Open the *.csv file in Microsoft Excel.
4. In Excel, highlight the data, then in the “Data” pulldown, use the “Text to Columns” function to convert the data into columnar format; the divider is a semicolon.
5. Your data is now in nice columns by date and time, so you can plot it out as you wish.

1.1.4 Gather sky survey

The SQM-LU-DL-V is capable of gathering a complete sky-survey of brightness from one location with the built-in Altitude and Azimuth sensor by pointing the meter at various locations in the sky.

Follow these steps to gather the sky-survey data:

1. Connect the meter to the PC and use UDM Data Logging tab to:
 - a) Ensure that meter has the correct time.
 - b) Set the vibration threshold to 500. This ensures that the meter will only collect brightness samples when the device is held still.

- c) Set the datalogging trigger to once per second and then disconnect the meter from the PC.
2. Go outside to the desired location and connect the battery to the meter as shown in Figure ???. The LED will come on for 3 seconds initially then come on once per second recording every one second as long as the meter is not moved around too much.



Figure 1.1: Handheld battery pack

3. Point the meter at the starting location in your survey and hold it still while waiting at least one second. The LED will flash for each reading taken.
4. Point the meter at the next location and wait at least one second for a reading to be gathered (LED will flash).
5. Repeat the above step until the entire sky is covered (about 20 degree steps apart should suffice).
6. Disconnect the battery and connect the meter to the PC. The meter will still be recording every one second.
7. Use UDM to turn off datalogging, select trigger = Off.
8. Use UDM to retrieve all the records.
9. Note: Moving the meter around slightly while connected to the computer will prevent readings from being taken. Use this technique if you do not want to edit out those useless readings from the log file later.
10. To generate an all-sky map, follow the instructions in ???.

Live Altitude/Azimuth view

You can test the magnetic effect on the meter by watching the live view of azimuth (as seen in Figure ??) with UDM as follows:

1. Go to the “Vector” tab.
2. Press the “Calibrate-vector button” to reveal a new window.
3. Select the “Overview” tab.
4. Press the “Monitor” toggle button ON.
5. Move the meter about to see both Altitude and Azimuth change.
6. Move magnetic parts near the meter to see the effect on Azimuth. See Figure ?? for the location of the Altitude/Azimuth co-processor.
7. The Zenith level display shows a “bubble” style level gauge that is centered when the meter is point at the Zenith.
8. Press the “Monitor” toggle button OFF.
9. You can close the calibrate dialog to go back to normal UDM operation.

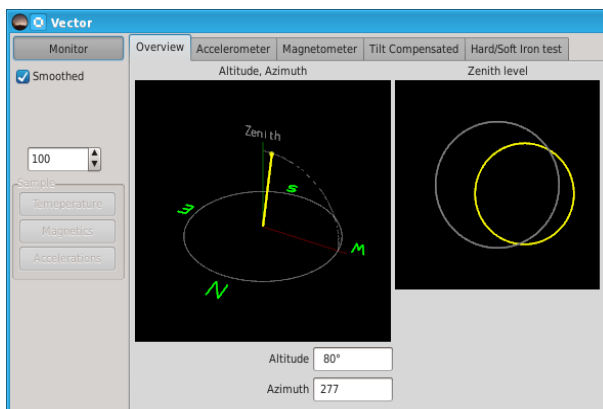

Figure 1.2: Live Altitude/Azimuth view



Figure 1.3: Vector co-processor cutaway view

1.1.5 Other software

- If you are using Windows, you may want to use Knightware SQM-Reader from www.knightware.biz/sqm .
- The CD contains examples of software (Perl, Python, etc.) for various functions that connect to the meter.

1.1.6 FITS integration

Some programs (listed below) gather information from the Unihedron Sky Quality meter products and insert that data into the Flexible Image Transport System (FITS) header.

- MaxPilote (Freeware) incorporates SQM readings from an SQM-LE/SQM-LU into the FITS header while at the same time provide constant readings in a live and updated Data Window.
- CCDAutoPilot
- FITS4Win2 uses the MPSAS keyword for sorting and filtering image files.

2 Measurements

The SQM-LU-DL-V provides readings in Magnitudes per square arcsecond, abbreviated as: mpsas, and written mathematically as $\frac{mag}{arcsec^2}$.

Mpsas is a logarithmic measurement which means that large changes in sky brightness correspond to relatively small numerical changes. A difference of 5 magnitudes is a factor of 100 times the intensity. Therefore a sky brightness $5.0 \frac{mag}{arcsec^2}$ darker corresponds to a reduction in photon arrival rate of a factor of 100.

The following schematic gives a rough idea of how to interpret the readings of the SQM:

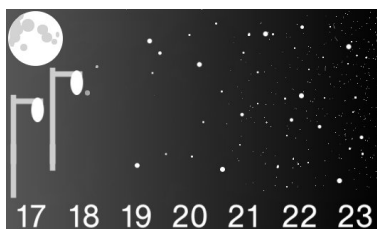

Figure 2.1: Mpsas interpretive scale

Magnitudes are an astronomical unit of measure for object brightness. Brighter objects have a lower magnitude and darker objects have a higher magnitude value. For example; a star that is 6th magnitude is brighter than a star that is 11th magnitude.

The star Vega is used as the reference point of ≈ 0 magnitude. Table 2.1 shows the apparent magnitude of some commonly known celestial objects.

Table 2.1: Apparent Magnitudes of Known Celestial Objects adapted from [2]

App. Mag.	Celestial Object
-26.73	Sun
-12.6	full Moon
-4.7	Maximum brightness of Venus
+0.03	Vega, the original zero point
+6	Faintest stars observable with naked eye
+27	Faintest objects observable in visible light with 8m ground-based telescopes
+30	Faintest objects observable in visible light with Hubble Space Telescope

Arcsecond is the definition of an arc being divided up into seconds as follows.

1. There are 360 degrees in a circle.
2. There are 60 arcminutes in a degree, and 21600 arcminutes in a circle.
3. There are 60 arcseconds in an arcminute, and 1296000 arcseconds in a circle.

Square arcsecond (arcsec^2) is the area covered by a square measuring $1\text{arcsec} \times 1\text{arcsec}$.

Magnitude per square arcsecond is the definition of brightness in magnitudes spread out over one square arcsecond of the sky. For example; if the SQM provides a reading of 20.00 mpsas, that would be like saying that a light of a 20th magnitude star brightness was spread over one square arcsecond of the sky.

The "magnitudes per square arcsecond" numbers are commonly used in astronomy to measure sky brightness. More details can be found at www.stjarnhimlen.se/comp/radfaq.html

Each magnitude lower (numerically) means just over 2.5 times as much more light is coming from a given patch of sky. A change of 5 mags/sq arcsec means the sky is 100x brighter.

The darkest we've personally experienced with the SQM in a natural clear sky was 21.80.

2.1 Getting accurate readings

Various factors will cause the night sky brightness to fluctuate. Taking more readings will be useful in ruling out spurious events. The SQM gathers light for at least a one second period, and the brightness report is based on the light that was accumulated during that time.

At the darkest sites, natural variations in conditions such as airglow and the brightness of the zodiacal light are limiting factors.

Prevent artificially high (dark) readings by ensuring that there is nothing blocking the view of the sensor. Avoid taking readings near trees or buildings that may block the sensor.

A reading of greater than 22.0 is unlikely to be recorded, however there are reasons for extra dark readings:

- Cloud or ash covered sky in a remote area where little natural sky brightness can be recorded.
- Uncorrected readings from covered meter like a weatherproof housing.
- Obstructed view like inside a forest, or where large buildings are located within the field of view, or a person or bird blocking the view.

When the sky is very dark, the meter takes longer to gather enough light to produce a reading. During this time of light gathering, the reading will remain constant until the meter can start gathering readings fast enough for new reading-requests.

The readings are averaged in an 8-cell rolling buffer, so it may take a while for the meter to produce a new value of darkness when obstructions leave the field of view.

Prevent artificially low (bright) readings by ensuring that there are no lighted objects (street lamps, the moon, etc.) that shine into the sensor at any angle.

2.1.1 Seeing conditions

Scintillation is due to refractive changes in the atmosphere caused by temperature changes at differing heights.

Stars are too small in comparison to the entire SQM field of view, so scintillation is not expected to alter the SQM reading significantly.

2.1.2 Light pollution

Undesirable artificial light that reaches you is considered to be light pollution. Much of this light comes from outdoor illumination of parking lots, street lamps, office buildings, advertising signs, etc..

Other causes of extra light in the night sky are listed below:

Aurora

Charged particles emitted from the Sun are directed to the poles of the earth by the Earth's magnetic field. These particles collide with atoms in the atmosphere and cause light to be emitted. Aiming the meter at the polar regions during Aurora Borealis (in the North) or Aurora Australis (in the South) will reduce the reading (lighter). Aiming the meter towards the equator will increase the reading (darker) under these conditions.

Airglow

Airglow is light produced by various phenomenon in the atmosphere which prevent the sky from being totally dark. Effects of the magnetic poles of the Earth may cause airglow to be brighter near the poles.

The Milky Way

As one goes to sites with darker surface brightnesses, the fraction of the total light received by the SQM-LU-DL-V which can be attributed to the Milky Way bulge increases and so the "offset" in mpsas will be larger (due to the Milky Way.)

The northern view of the Milky Way contributes about 0.10 mpsas under 21.5 mpsas (moonless) skies.

The southern view of the Milky Way might be as big an effect as 0.56 mpsas in dark skies where it goes near-overhead.

For more information, see Surface Photometries of the Milky Way (Schlosser+ 1997)

vizier.u-strasbg.fr/ftp/cats/VII/199/ReadMe

Moisture

Clouds, fog, and mist will reflect artificial light back down to the Earth causing a brighter (lower) reading. If there is no artificial light, then clouds may prevent starlight from coming to you and the reading will be darker (higher). This extra-dark situation can occur in very isolated areas like mountain tops, the ocean, or the desert. You will have to be aware of this special situation when analyzing readings.

Volcanic eruptions

Dust released into the atmosphere by volcanoes can reflect light from the surface of the earth back down. In a dark location this dust will prevent the light from stars and Milky Way and produce a darker (higher) reading.

Zodiacal light

The sunlight reflected off of dust particles in the ecliptic plane of our solar system is called zodiacal light.

The amount of light will be different depending on whether the meter is pointed to the poles or plane of the solar system. It is likely to have less than 2% effect. The primary reason for this small effect is that the brightest and widest part of the zodiacal light is nearest the horizon where the SQM has almost no sensitivity (due to it being a primarily zenith-looking device). The portions at higher altitude are the narrowest and faintest and they would barely creep into the sensitivity cone of the SQM.

2.1.3 Other luminance scales

Candela per square meter (cd/m^2) is commonly used by lighting engineers.

To convert the SQM mpsas reading to cd/m^2 , use Equation (2.1):

$$[\text{cd}/\text{m}^2] = 10.8 \times 10^4 \times 10^{(-0.4 \times [\text{mag}/\text{arcsec}^2])} \quad (2.1)$$

Naked eye limiting magnitude (NELM)

Quite often astronomers will refer to a sky by the darkest star they can see, for example a "6th magnitude sky", in that case you can see 6th magnitude stars and nothing dimmer like 7th magnitude stars. The term "6th magnitude skies" is very subjective to a person's ability to see in the night, for example an older person might say "5th magnitude skies" but a young child with better night vision might say "7th magnitude skies".

No one has performed the task of defining a relationship between the two methods of sky brightness (x magnitude skies and magnitudes per square arcsecond) – probably because one is subjective and the other is objective and a wide variety of people would have to be polled.

An approximation exists for the conversion between NELM and MPSAS. You can use an NELM converter[5] created by SQM user K. Fisher to do that conversion, or the chart shown in Figure 2.2 and Equations (2.2) and (2.3).

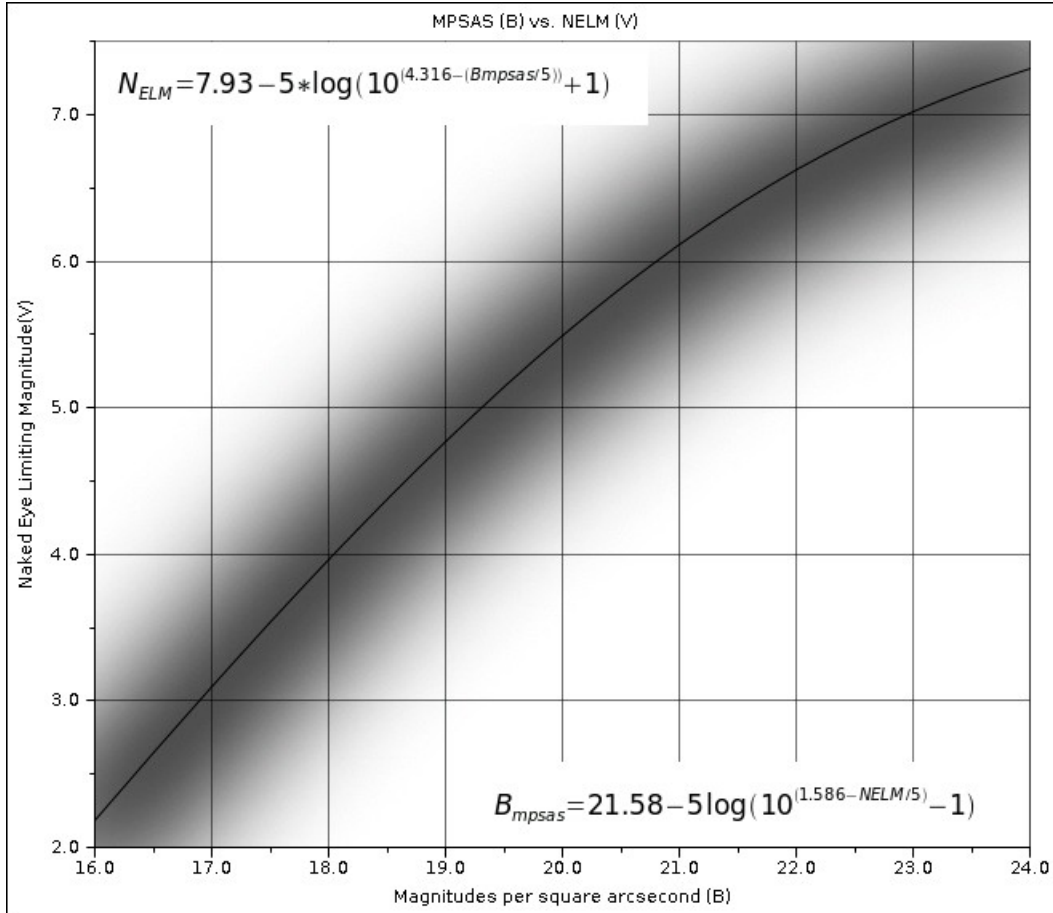

Figure 2.2: Mpsas vs NELM

Convert NELM (V mags) to MPSAS (B) sky brightness [3]

$$B_{mpsas} = 21.58 - 5 \times \log(10^{(1.586 - NELM/5)} - 1) \quad (2.2)$$

Convert MPSAS (B) sky brightness to NELM (V mags) [4]

$$NELM = 7.93 - 5 \times \log(10^{(4.316 - (B_{mpsas}/5))} + 1) \quad (2.3)$$

NSU

Natural Sky Units [1] (NSU) is radiance relative to an assumed natural radiance of 21.6 magSQM/arcsec² .

NSU values indicate how much brighter or darker the sky is compared to a typical historic clear night sky. It is defined here as $NSU = 10^{0.4\Delta}$ where Δ is 21.6 minus the observed value in magSQM/arcsec².

3 Theory of operation

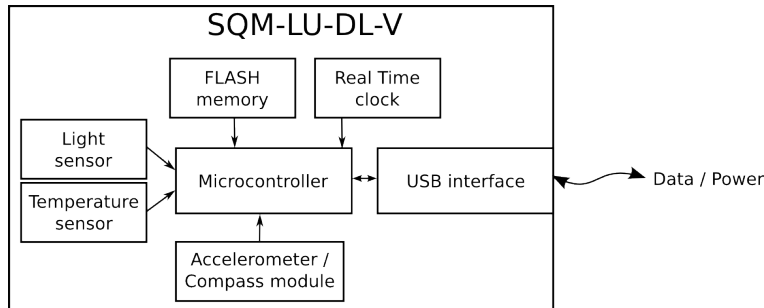

Figure 3.1: SQM-LU-DL-V Block diagram

3.1 Light measurement

The SQM-LU-DL-V measures the darkness of the night sky to provide readings of magnitudes per square arc second through the USB connection. the SQM-LU-DL-V is capable of internally recording readings.

A light to frequency sensor (TSL237) provides the micro-controller with a signal whose frequency depends on the amount of incoming light. And, readings from the temperature sensor are used to compensate the light sensor readings through the range of operating temperatures.

In bright skies, the sensor produces a high frequency square wave (up to 500kHz). As the sky gets dark, the sensor produces a low frequency. In absolute darkness, the sensor period is very long, and is defined on the calibration sheet as “Dark period” with a 300s timeout.

Measurement of this wide range of frequencies is done by timers and counters inside the microprocessor. It is difficult for a microprocessor to accurately measure the period of high frequency signals, and just as difficult to measure the frequency of extremely low frequency signals. For this reason the microprocessor has two modes of signal measuring:

Frequency mode: The frequency mode is for bright readings where the frequency is high. The sensor signal is fed into a counter that is gated at one second intervals to report a frequency measured in Hz.

Period mode: The period mode is for dark readings where the frequency is low. The sensor signal gates a high speed internal counter which reports the period measured in μ s.

Both *Frequency* and *Period* results are available when connected directly to the meter and using the “rx” command.

The SQM-LU-DL-V computes mpsas by deciding if the period or frequency report should be used and then compensating for temperature. Deciding between period or frequency mode reporting was originally done at a frequency of 354Hz, but by selecting the “Ideal crossover firmware” setting on the “Report interval” page, the switchover will be 679Hz which offers the best resolution at the switchover point.

The SQM-LU-DL-V holds the updated period and frequency recordings in memory while waiting for an asynchronous user request for a reading. It is possible for the user to see stale readings if the light sensor cannot gather enough light to produce a reading before the user asks for the next report (i.e. using the “rx” command too frequently). Starting at firmware version 58, the SQM-LU-DL-V can provide a status of the reading that the user has requested by using the “r1x” command which contains a status suffix character of F/P/S whose meaning is:

F: fresh FREQUENCY mode reading.

P: fresh PERIOD mode reading.

S: STALE reading indicates that this reading has not changed since the last reading because there was not enough light gathered to produce a new reading.

3.2 Altitude (inclination) measurement

The SQM-LU-DL-V gathers “altitude” (inclination) readings by using a 3D accelerometer. The Earth’s gravitational directional is the reference. Since an accelerometer is used, rapid changes in direction of the meter also affect the reading of altitude. A vibration reading is also available to assist in indicating when the unit is mechanically stable enough to take a reading.

3.3 Azimuth (heading) measurement

The SQM-LU-DL-V gathers “azimuth” (heading) readings by using a 3D magnetometer (compass). The Earth’s magnetic field is the reference. Since a magnetometer is used, nearby magnetic fields will affect the reading of azimuth. The best way to check if the meter is affected is to use the “Vector” tab and observe the live azimuth reading while the meter is located close to various objects (like a metal tripod or the battery pack).

The battery pack included with the the SQM-LU-DL-V has steel connections which are magnetized enough to affect the reading if placed too close to the meter’s internal compass module. Place the battery pack as far as possible from the meter. Locating the battery pack near the USB connector is fine.

If you are holding the meter, make sure sure that any jewelry is non-magnetic or removed.

3.4 Communication to the PC

Commands sent from a PC through the USB cable to the USB interface are relayed to the micro-controller.

The micro-controller responds to commands by sending data strings to the USB interface which are then relayed to the PC.

Readings are gathered asynchronously by the micro-controller. Requests from the PC are buffered and dealt with as time permits.

4 Specifications

USB connection	USB B connector. 5m USB A to USB B cable supplied. USB FTDI VCP driver, serial port emulator at 115200baud.
Physical Size	5.521" x 2.607" x 1.102" [140.22 x 66.22 x 28.00cm]
Meter weight	110g
Battery pack with batteries weight	120g
USB cable weight	140g
Meter precision	Each SQM-LU-DL-V is factory-calibrated. The absolute precision of each meter is believed to be $\pm 10\%$ (± 0.10 mag/arcsec ²). The difference in zero-point between each calibrated meter is typically $\pm 10\%$ (± 0.10 mag/arcsec ²)
Power requirement	18mA (from the 5V USB connection). Can be put to sleep and woken up for battery operated data logging. 3.42V minimum under battery operation. The included battery adapter can handle up to 30VDC.
Operating temperature range	-40°C to 85°C
Temperature sensor	Accuracy: $\pm 2^\circ\text{C}$ maximum at 25°C Location: Internal near light sensor, measures internal meter temperature for light sensor value compensation.
Temperature update rate	4.3 seconds, 256 samples taken at 60Hz then averaged.
Data logging capacity	128MB Flash chip, 32 bytes per record= 524288 records total.
Vector measurements	Pololu 2127 3D accelerometer/magnetometer module using the STMicroelectronics LSM303D.
Real Time Clock accuracy	Original datalogger unit (RTC DS1305): +1.73s/day @25°C, -2.27s/day @50°C, per Citizen crystal CFS206-32.768KDZB-UB Version R1 datalogger unit (RTC DS3234): ± 3.5 ppm Version R2 datalogger unit (RTC DS1390): ± 5 ppm



Figure 4.1: Front and back of unit

5 Hardware connections

The SQM-LU-DL-V requires one connection to a USB hub or a PC for configuring the device and recovering the readings as shown in Figure 5.1.

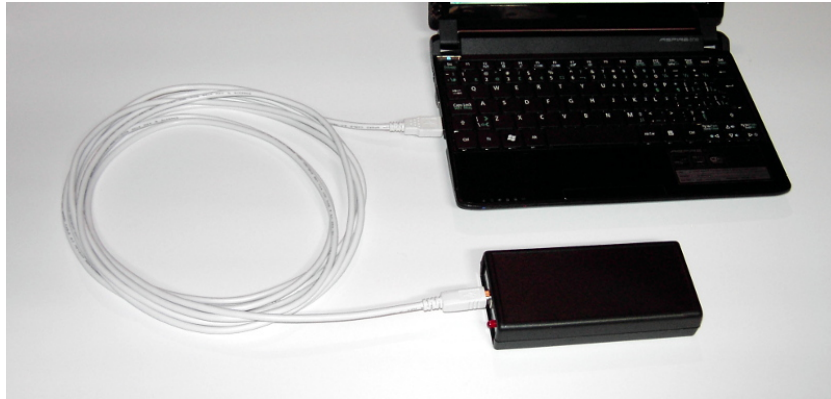

Figure 5.1: Wired connection

The maximum length cable per the USB specification is 15ft (3m). USB extenders exist on the market, some work up to 198ft (60m).

A battery adaptor with batteries is supplied to allow the SQM-LU-DL-V to perform data-logging while disconnected from the computer. This battery connection replaces the USB connection from the computer as shown in Figure 5.2.



Figure 5.2: Battery connection

5.1 Battery operation

The SQM-LU-DL-V may be operated by an external battery using the supplied “battery to USB adaptor”. The lifetime of the battery can be determined as shown below. This calculation is also performed and displayed by the UDM software on the “Data Logging” panel. Figure 5.3 shows experimental results of the current profile using a 10 Ω current shunt.

On the first power-up, the internal super-capacitor, used to power the RTC, is charged. After that charging time (possibly hours later), then the quiescent current is reached.

Current consumption values:

$$I_Q = 209\mu A \quad \text{Quiescent current} \quad (5.1)$$

$$I_W = 10mA \quad \text{Wake current} \quad (5.2)$$

$$I_M = 55mA \quad \text{Measure current} \quad (5.3)$$

Current consumption timing:

$$t_Q = 1 - (t_W + t_M) \quad (5.4)$$

$$t_W = \frac{3s}{60s} \quad (5.5)$$

$$t_M = \frac{5s}{n \times 60s} \quad (5.6)$$

$$n = \text{number of minutes between samples} \quad (5.7)$$

Current consumption formula:

$$I_{Avg} = t_Q \times I_Q + t_W \times I_W + t_M \times I_M \quad (5.8)$$

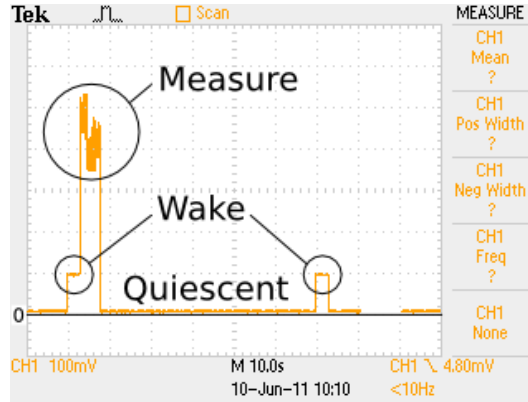

Figure 5.3: Current profile

As an example for determining battery life of a 3AH battery with sampling every 5 minutes:

$$T_{Batt} = \frac{AH_{Rating}}{I_{Average}} \quad (5.9)$$

$$= \frac{AH_{Rating}}{(I_Q \times t_Q + t_W \times I_W + t_M \times I_M)} \quad (5.10)$$

$$= \frac{3AH}{(209\mu A \times 0.93 + \frac{3s}{60s} \times 10mA + \frac{5s}{5 \times 60s} \times 55mA)} \quad (5.11)$$

$$= 1861 \text{ hrs, or 78 days, or 2.5 months} \quad (5.12)$$

Note that measuring is still performed for "Threshold" settings, even when it is too bright to record a reading. Measuring is performed to determine this "measure" state, and $I_{Measure}$ still applies.

5.1.1 Battery performance

A test of various popular batteries at room temperature resulted in the following lifespans for the SQM-LU-DL connected to the six AA cell battery holder with triggering set to “Every 5 minutes on the 1/12th hour”:

Table 5.1: Battery performance

Battery (six AA cells)	Lifespan (at room temperature)
Procell Intense Alkaline AA	272 days, or 8 months and 29 days
Energizer Ultimate Lithium	232 days, or 7 months and 19 days
EDL NiMH 2800 mAh	170 days, or 5 months and 19 days
Blackube Rechargeable Li-ion	126 days, or 4 months and 5 days

Actual outdoor performance with lower temperatures will result in shorter lifespans. We have had no problems with a one to two month session before retrieving data and replacing the batteries.

Alkaline batteries have much lower capacity below freezing and cease to function at all below -18 deg Celsius = -0.4 deg Fahrenheit. For cold temperature environments, Li-ion batteries are much preferred.

The capacity of NiMH is not as good as Alkaline especially if the NiMH have been frequently recharged.

In extremely darker places than an open sky, the meter will stay on taking a reading for longer than usual time and that could chew through capacity regardless of the battery chemistry.

5.1.2 Solar charger

When using the solar charger with NiMH batteries, the batteries will be charged during sunlight hours, and the measured battery voltage will be recorded.

We recommend using the solar charger unit with fresh and recently-charged NiMH batteries. Wirecutter in the New York Times has compared available brands of NiMH AA batteries recently here:
www.nytimes.com/wirecutter/reviews/best-rechargeable-batteries/

As of this writing (March 2025), the best picks are:

- EBL NiMH AA 2,800 mAh
- HiQuick NiMH AA 2,800 mAh
- Tenergy Premium Pro NiMH AA 2,800 mAh

For most temperate or tropical sites, sufficient sunlight will be available during the day to recharge the NiMH batteries from night to night indefinitely. However, near-freezing temperatures (or lower) will result in lower capacity and probable reduced lifetime. Locations with significant snowfall and/or long periods of cloudy weather may not be suitable for long-duration, unattended SQM-DLHSC monitoring. In such cases, a high-capacity Li-ion battery pack attached to an SQM-LU-DL would be more appropriate.

NiMH batteries are considered damaged if the voltage falls below 0.9V per cell. Such batteries will have much higher internal resistances (200-500+ mOhms) than properly maintained NiMH cells (50-100 mOhms). Even if recharged, batteries that have had voltages lower than 0.9V will have significantly lower capacity in mAh.

Figure 5.4 shows the battery being charged during the days and discharged during the nights for many months, then the average voltage drops to slightly less than 5V for many months before exhibiting erratic behaviour with recorded dropouts around 4.4V. The square red boxes indicate that the meter thinks it has been reconnected because the battery voltage was too low. The MPSAS readings have been suppressed for this plot.

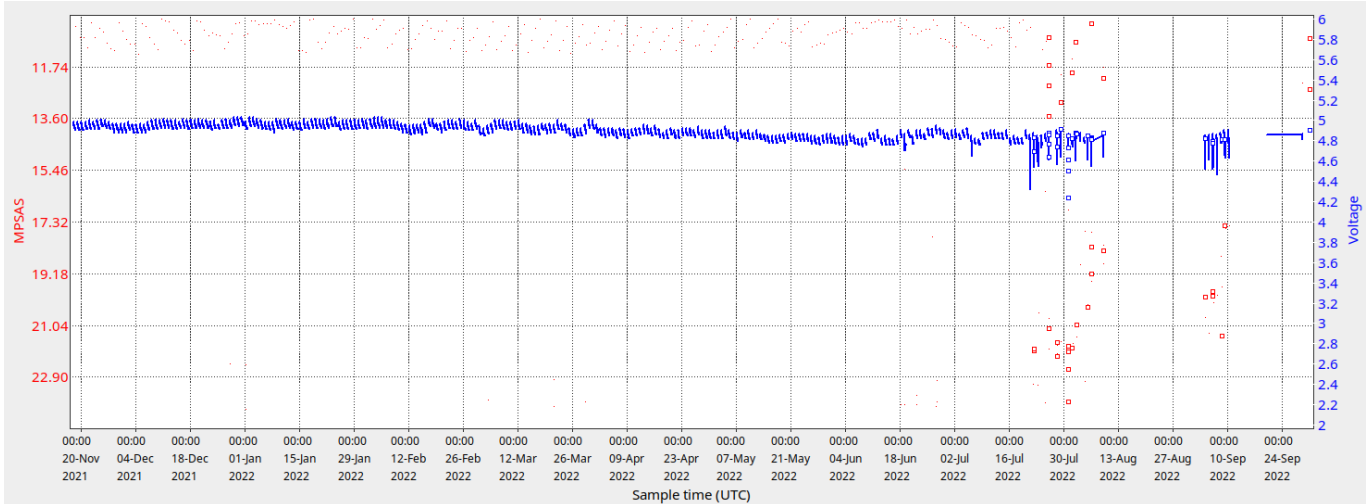

Figure 5.4: Battery discharge plot

5.2 Diagnostic LED

When the unit is connected to a battery, the red LED near the USB connector will illuminate in the sequence shown in Figure 5.5 (firmware ≥ 26). Note: The LED will flash when waking up, but will not flash during the “Every x seconds” mode.

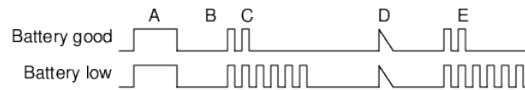

Figure 5.5: Diagnostic LED timing diagram

Description of LED flashes:

- A On for three seconds during the power-up/boot-load sequence. During this time, the unit is supplying power to the sensor components and will also accept firmware updates.
- B Log a reading if it is scheduled and is above the set threshold. The meter requires about 8 seconds to gather a valid reading, Some readings may take much longer (300s max) to acquire. The SQM-LU-DL-V provides one LED blink after taking the reading.
- C Shutdown: One quick flash for normal battery voltage (above 4.9V), more quick flashes if the battery voltage is too low (2:4.8V, 3:4.6V, 4:4.4V, 5:4.2V, 6:4.0V). Battery voltage detection is performed at the end of the light meter reading time (B) because low batteries drop during power drain and this is the voltage that the light meter reading was recorded at.
- D Wake from sleep at the minute mark to check if a recording should be logged. The LED comes on bright then fades off within one second. Firmware before feature 49 had this step leave the LED on for three seconds solid.
- E Same as step C.

6 Software development

The SQM-LU-DL-V uses the FTDI FT232R chip to communicate as a standard serial port device at 115200 baud using the FTDI software drivers which are available for all major operating system platforms. Drivers are available from www.ftdichip.com.

Once the driver is installed, commands can be sent to the SQM-LU-DL-V using a serial terminal emulator to the serial communications port that the device routes to.

When connecting the SQM-LU-DL-V to a PC where the FTDI device driver is loaded, the serial port label will be determined at connection time.

Each SQM-LU-DL-V has a unique serial number usually with a prefix of "FT.....". This serial number can be used to identify the exact SQM-LU-DL-V device from other USB devices.

6.1 Writing your own software interface

All of the commands and responses of the SQM-LU-DL-V are documented in Section 8.

To communicate with the SQM-LU-DL-V, the following general steps are required:

1. A serial 115200 baud connection must be made to the serial port assigned to the SQM-LU-DL-V.
2. Data commands are sent to the SQM-LU-DL-V, and it responds with a string of characters.
3. Close the serial port so that other programs can access the SQM-LU-DL-V. Note: Only one connection can be made to the SQM-LU-DL-V at a time. Therefore leaving a connection open constantly prevents other connections from being made.

Various examples of reading from the SQM devices are supplied on the CD and available at the Unihedron website.

Below is an example using Perl to read the SQM USB device:

Listing 6.1: Read SQM-LU using Perl

```
#!/usr/bin/perl

#Filename: read-sqmlu.pl
#Description: Utility to read Unihedron Sky Quality Meter-LU (USB model)

# Define the required module
use Device::SerialPort;

# Open and configure serial port
$port= Device::SerialPort->new("/dev/ttyUSB2");
$port->user_msg(ON);
$port->baudrate(115200);
$port->parity("none");
$port->stopbits(1);
$port->databits(8);
$port->handshake("none");
$port->write_settings || undef $port;
$port->read_char_time(1); # Wait for each character

# Send request to SQM
$port->write("rx\r");

# Get response from SQM
($count,$saw)=$port->read(255);
```

```
# Close the port so that other programs can use the SQM
$port->close;

# Print the SQM result to the screen
printf("%s", $saw);
```

The above program prints a result like this:

```
r, -09.42m, 0000005915Hz, 0000000000c, 0000000.000s, 027.0C
```

6.2 Pascal

The UDM program contains many examples of finding the SQM devices and reading data from them. It is open source and written in Lazarus/FreePascal. The source files for UDM are available here:

unihedron.com/projects/darksky/cd/udm/ .

7 Unihedron Device Manager

The Unihedron Device Manager (UDM) program is intended for use in maintaining and testing the Unihedron connected Sky Quality Meter products. Windows, Mac, Linux versions of UDM are available on the supplied CD. It is used to:

- Read version information.
- Request readings.
- Read and set calibration data.
- Read and set all other meter parameters.
- Install new firmware.
- Setup and retrieve data from datalogging meters.
- Continuously log data from connected meters.

7.1 Getting UDM

UDM is supplied on the CD that shipped with the SQM-LU-DL-V. The latest version of UDM is available at the Unihedron website at this location

www.unihedron.com/projects/darksky/cd/

7.2 Installation

7.2.1 System requirements

The UDM is a fairly simple (but large) program which should run sufficiently on any present-day computer under the Windows, Mac, or Linux operating systems.

The Windows version of UDM can also be run in a virtualization mode using VMware Fusion. Access to the network is achieved by the menu **Virtual Machine > Network Adapter > Bridged (Autodetect)** being checked.

7.2.2 Windows

The Windows version of UDM is in a setup.exe style file located in the Windows subdirectory of the CD, for example:

`\Windows\setup1.0.0.38.exe`

Simply double-click on that file to start the installation procedure.

Note: Some antivirus software may prevent installation of UDM. Try disabling the antivirus software before installing UDM, or try right-clicking on the setup.exe file and "Run as admin".

7.2.3 Mac

The Mac OSX version of UDM is a dmg file located in the Mac subdirectory of the CD, for example:

`/Mac/udm.app.dmg`

Drag the app to the `/Applications` directory.

7.2.4 Linux

The Linux version of UDM is available in a Debian package separately for both 32bit and 64bit systems located in the Linux directory of the CD, for example:

`/Linux/udm_20140821-1_i386.deb`

Open the file with package installer program like GDebi.

7.3 Operation

After starting UDM, a list of found devices should appear, if your device is not listed on the screen, try clicking “Find” once more to search for connected devices.

If more than one SQM device is found, then you will have to select (click) on one of the devices, otherwise if only one device is found, then click on “Version” or “Reading” of the information tab for more information.

The tabs can be used to select various functions when working with your selected device. These tabs and their functions are described further in this document.

7.3.1 Start up

After starting the UDM program, a splash screen shown in Figure 7.1 is temporarily shown while the program searches for attached devices.

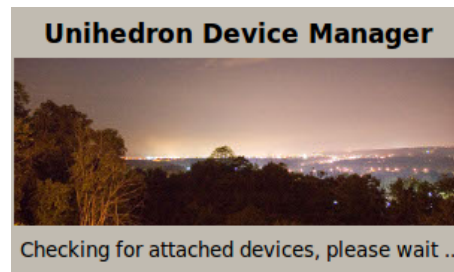

Figure 7.1: Splash screen

1. UDM searches for attached USB devices first. This step is fairly quick (a few seconds).
2. UDM then searches for attached Ethernet devices within the reach of the Ethernet network but not outside a firewall. This step may take about 30 seconds.

If no devices are found, then the main UDM program will be shown with the “found devices box” empty. You can attach an SQM device to your computer and press the “Find” button to search for the newly connected devices.

If you know that an Ethernet device is connected but it does not show up, then a network problem may be the cause. Also check the power connection to the SQM-LE.

If you know that a USB device is connected but it does not show up, then there may be a device driver issue. Check the USB device listing for your operating system. These USB devices should appear as a COMM port. Also, check the troubleshooting notes in section 13 on page 115 for possible solutions.

7.3.2 Main screen

The main screen of UDM consist of the following sections:

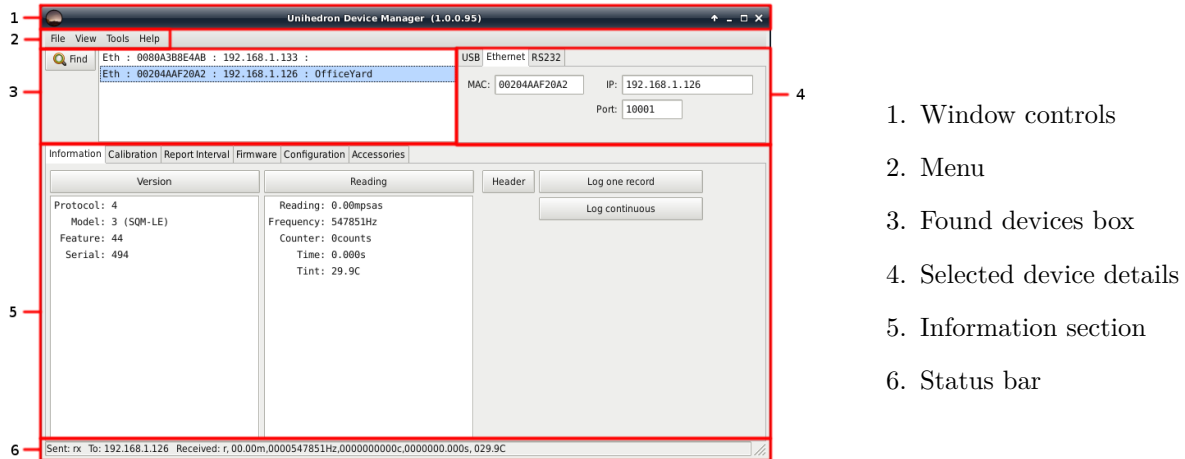

1. Window controls
2. Menu
3. Found devices box
4. Selected device details
5. Information section
6. Status bar

7.3.3 Main menu

The main menu of UDM consists of the items; File, View, Tools, Help as defined below.

7.3.4 File menu

The file menu is used for: opening files, finding newly attached devices, and quitting the program as shown in Figure 7.2.



Figure 7.2: File menu

File : Open

The “File : Open” menu item is used to open up previously stored log files or calibration reports.

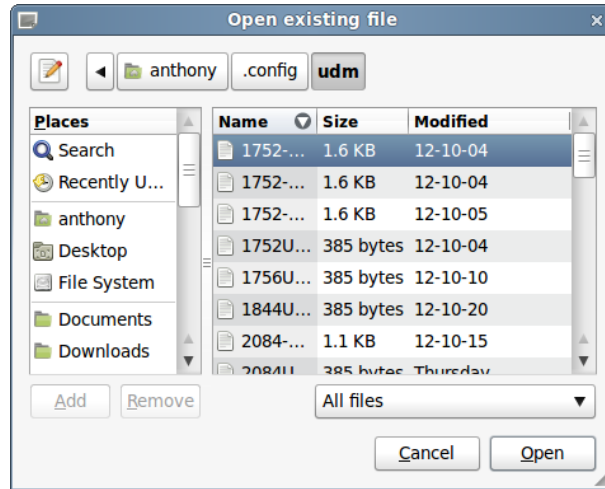

Figure 7.3: File Open dialog

File : Find USB

The “File : Find USB” function can be used to only find attached USB devices and ignore possible Ethernet devices. The hotkey Ctrl+U can also be used instead of the mouse.

File : Find Ethernet

The “File : Find Ethernet” function can be used to only find attached Ethernet devices and ignore possible USB devices. The hotkey Ctrl+E can also be used instead of the mouse.

File : Startup options

The “File : Startup options” function can be used to set the command line startup parameters internally so that these parameters are not needed on the command line. See 7.13 for more details on the available options.

File : Quit

The “File : Quit” menu item is used to close the UDM program.

The program can also be closed from the window panel “X”.

7.3.5 View menu

The view menu allows you to enable various tabs and check other settings of the UDM program.

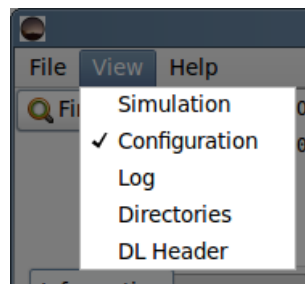

Figure 7.4: View menu

View : Simulation

Click on “View : Simulation” to toggle visibility of the “Simulation” tab. The Simulation tab can be used to send requests to the SQM-LU-DL-V to simulate conversions of frequency and period to light meter values. See page 71 for more details.

View : Configuration

Click on “View : Configuration” to toggle visibility of the “Configuration” tab. The Configuration tab is used to configure the SQM with its calibration values when calibrated light and dark settings are being performed.

View : Log

shows a window of commands and responses sent to and received from the SQM during this session of running UDM. Some excessively repetitive commands are suppressed from this listing. The hotkey Ctrl+L can also be used instead of the mouse.

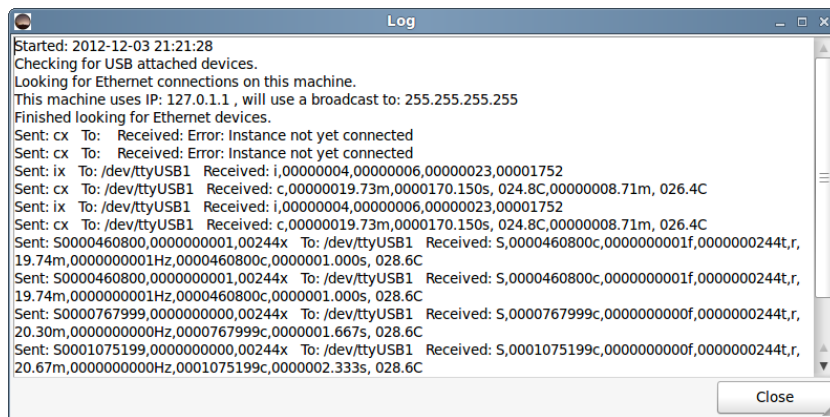

Figure 7.5: View : Log

View : Directories

shows the directory paths used by UDM to store and retrieve data.

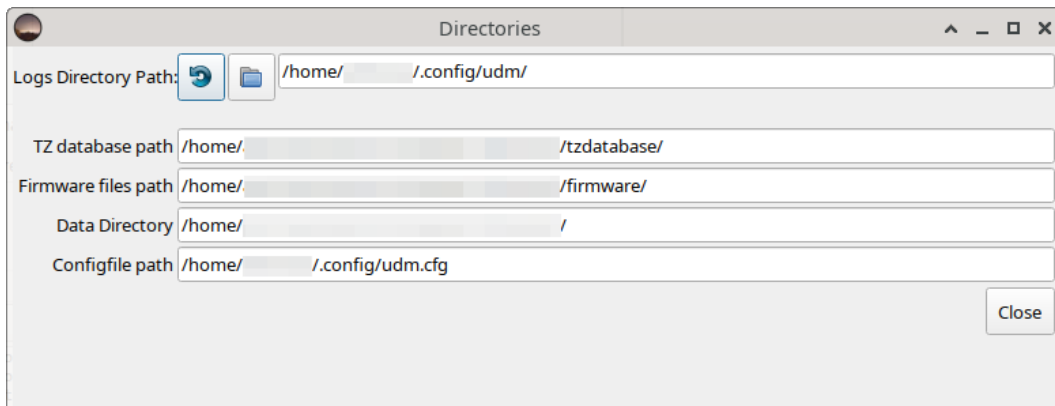

Figure 7.6: View:Directories

Logs Directory Path shows the path where logged records are kept. These logged records are created when using the “Log one Record” or “Log Continuously” features. Also, log files from data-logging meters will be stored here from the “Retrieve All” function.

The “Logs Directory Path” path can be changed from its default by pressing the folder button the right. After the path has been changed, new log files will be stored in that new folder.

UDM operations are logged in files labelled `SNnnnn.log` and `udm.log` which are text files that are handy for troubleshooting.

Table 7.2: Default Logs Directory Path

OS	Location
Windows	<code>C:\ProgramData\Unihedron\logs\</code> The Windows File Explorer may hide the directory. Open File Explorer, click on the “View” tab, and check the “Hidden items” box.
Linux	<code>/home/user/.config/udm/</code>
Mac	<code>/Users/user/Documents/udm/</code>

TZ database path The Time Zone information is required for datalogging purposes because the timestamp is logged as UTC. Since time zones change over the years, the entire Time Zone database is required and hence distributed with UDM and stored at the displayed “TZ database path”. This path is not changeable.

The Time Zone database is taken from: <https://www.iana.org/time-zones>

Firmware files path The firmware for the SQM-LU-DL-V can be updated or reverted using UDM. These firmware files are stored at the displayed firmware files path. This path is not changeable.

Data Directory is the place where some data files are kept, specifically the change-log for UDM and firmware files. This path is not changeable.

Configfile path is the place where UDM stores its configuration about the program and attached SQM devices. This path is not changeable.

Table 7.3: Configfile path

OS	Location
Windows	<code>C:\ProgramData\Unihedron\udm.ini</code>
Linux	<code>/home/user/.config/udm.cfg</code>
Mac	<code>/Users/user/Documents/udm/udm.cfg</code>

View : DL Header shows the Data-logger header editing page. See the information at www.darksky.org/measurements for a detailed description of each field.

The screenshot shows a window titled "Datalogging header" with a "Selected serial number:" label. A red text box on the left contains the following information: "This information is not stored in the meter, it is stored in the computer. To copy this information to another computer, see: View-> Config browser". The main area contains several input fields and dropdown menus:

- Serial Number: 494
- Instrument ID: Yard
- Data supplier: (empty)
- Location name: Back_Yard
- Position (lat, lon, elev(m)): 43.18333333, -79.51666667, 173
- Local timezone region: northamerica
- Local timezone name: EST
- Time Synchronization: (empty)
- Moving / Stationary position: (dropdown)
- Moving / Fixed look direction: (dropdown)
- Number of channels: 1
- Cover Offset: (empty)
- Filters per channel: (dropdown)
- Measurement direction per channel: (empty)
- Field of view (degrees): (empty)
- Comments: Example comment

Buttons for "PDF", "Definitions online", "Edit", and "Close" are also visible.

Figure 7.7: Data logging header

DL : Position can be changed by pressing the Edit button which calls up the following dialog:

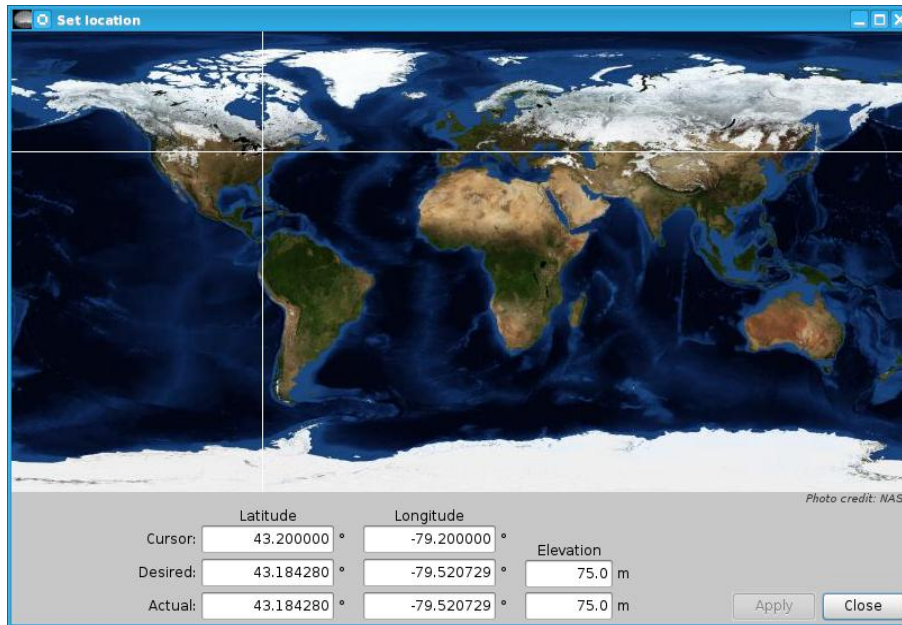

Figure 7.8: Set Location dialog

The “Set location” dialog is used to type in your location and have it verified on the world map. Use the following steps to set the location:

1. Type the exact location coordinates (in degrees) of the SQM-LU-DL-V into the “Desired” fields.
2. The mouse pointer can be used to select an approximate location if you are not sure of the exact coordinates.
3. The “Elevation” entry is optional as it is not used for anything yet.
4. Press the “Apply” button when you are satisfied with the desired values. Note: The “Apply” button will only be enabled if there is a difference between the desired and actual values.
5. Press “Close” when you are satisfied with the actual values.

The “Local timezone region” and “Local timezone name” are required by UDM to calculate local times of the recorded data before storing to disk. UTC timestamps are stored in the SQM-LU-DL-V.

The cover offset is a text only field that indicates what offset was used on the calibration data of the SQM-LU-DL-V.

View : Plotter The plotter window can be used to analyze .dat files recorded by UDM. An example shown below:

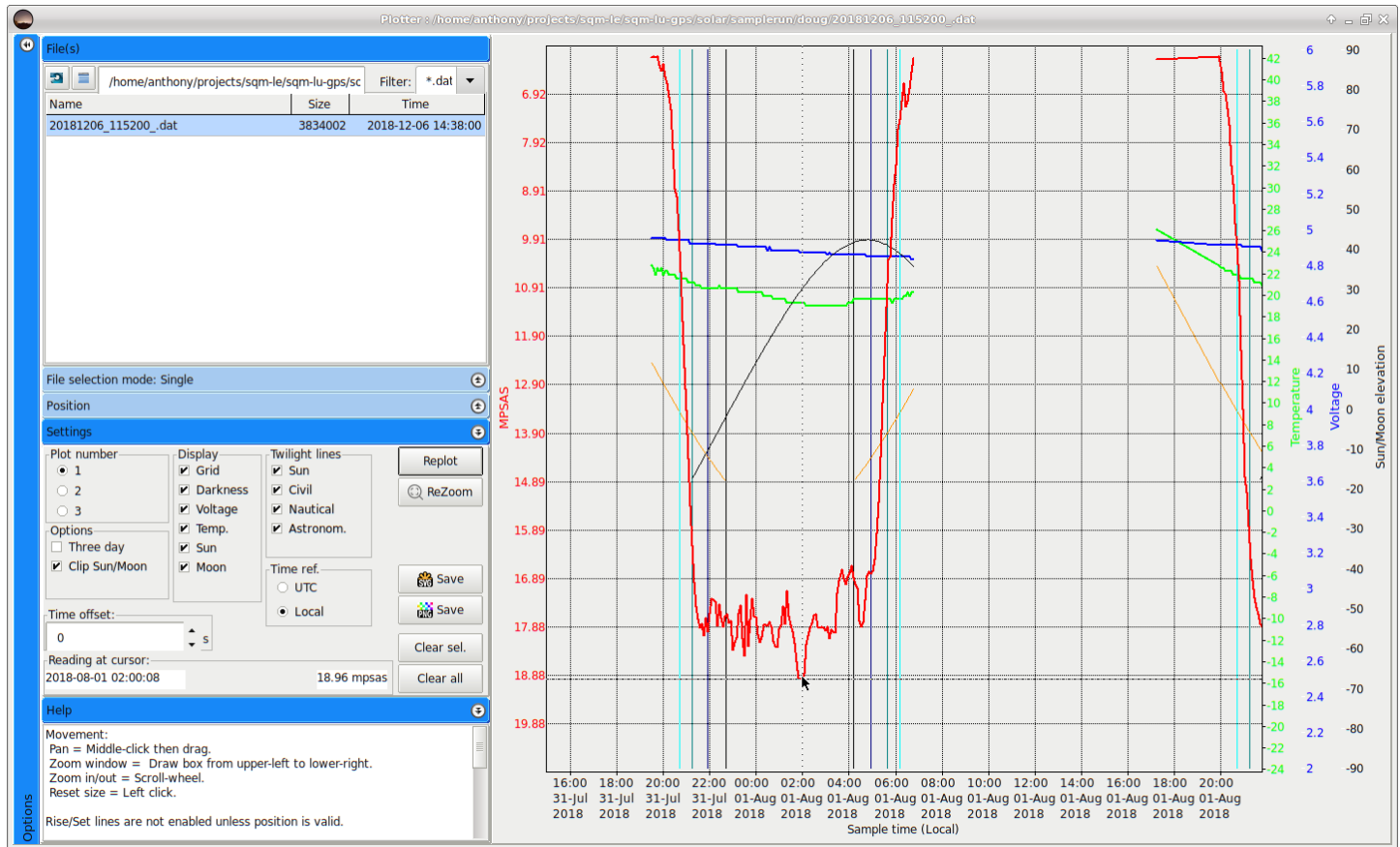

Figure 7.9: Plotter window

- The left sidebar tab be expanded and contracted by clicking on the tab title bars.
- Many data points can be optionally included from the “Settings” tab.
- The plotter can also display rise/set Twilight lines for the Sun.
- The “Help” tab shows some hints for zooming and also the line color definitions of plotted lines.
- The bare plot can be saved in vector graphics (SVG) or bitmap (PNG) modes using the “Save” buttons in the “Settings tab”. Note: SVG plots require that UDM can find the fonts used on the plotter (usually Arial).

View : Plotter : Time offset To assist in correcting timing problems when the datalogger real-time-clock was not properly set, the **Time offset** feature can be used as follows if there are two datalogger files, one with proper time set, and a second with bad time setting:

- Open the Plotter
- **File mode:** Multiple
- **Settings: Display:** Grid, and Darkness only, all other display selections can be unchecked.
- Select **Plot number:** 1, then click on the reference file (with the correct timing).
- Select **Plot number:** 2, then click on the problem file.

- Enter a starting **time offset** value.
- Press **Replot**.
- Alter the offset and replot until there is overlap of the two lines at a date and time that should be overlapping.
- Record the time offset and use it in the **Tools: .dat time correction** utility as follows ...
- press "**Select file**", then select the problem .dat file.
- Enter the **time difference** which you recorded earlier.
- Press "**Correct .dat file**".

View : Plotter : Customized colors and line widths The colors and width of plot lines and can be modified in the udm.ini/cfg file (found in the View:Directories:ConfigFile path). Edit the file with a text editor and place settings under the Plotter: section, for example: MPSASColor=clRed

The following names can be used to define plot line colors: MPSASColor MPSAS2Color MPSAS3Color MoonColor SunColor CivilColor NauticalColor AstronmicalColor SunTwilightColor VoltageColor TemperatureColor

Color names or numbers are defined here: https://wiki.freepascal.org/Colors#Convert_TColor_to.2Ffrom_string

The width of a line is defined with an integer number of pixels, for example: MPSASWidth=3

The following names can be used to define plot line widths: MPSASWidth MPSAS2Width MPSAS3Width MoonWidth SunWidth CivilWidth NauticalWidth AstronmicalWidth SunTwilightWidth VoltageWidth TemperatureWidth

7.3.6 Tools menu

Tools : old log to dat

The “old log to dat” tool is used to convert the original .log files that UDM created before the .dat file was made standard. Figure 7.10 shows the setup dialog for conversion.

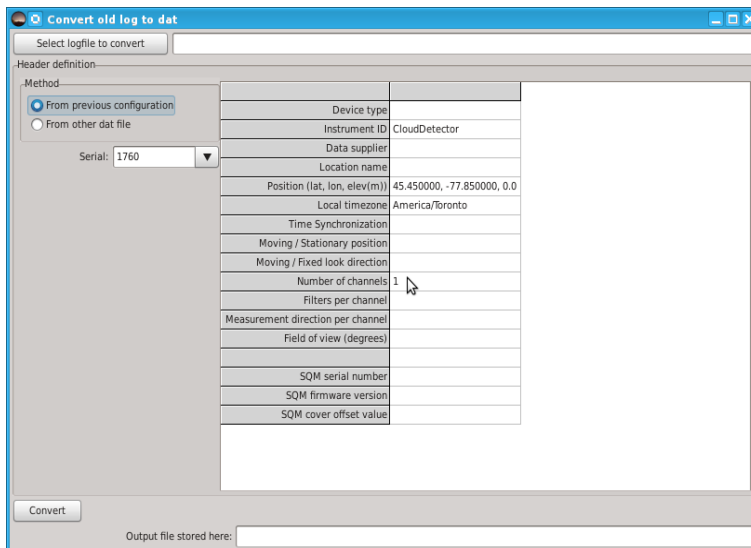

Figure 7.10: Tool : old log to dat

Tools : dat to Moon csv

The “dat to Moon csv” tool is used to convert .dat files to a csv file that contains Moon data using algorithm library from Andreas Hörstemeier [6]. This tool prepares the file for importation into a spreadsheet like Excel, OpenOffice, or LibreOffice. For importing into a spreadsheet.

The value for “Moon phase angle” reported in the .csv is:

- 180 or -180 = New Moon
- 0 = Full Moon
- Positive numbers Waxing (growing)
- Negative numbers Waning (shrinking)

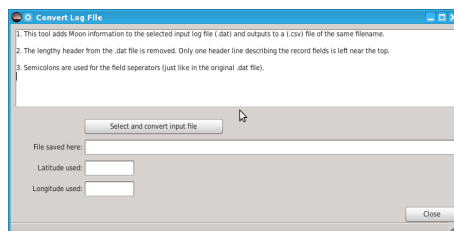

Figure 7.11: Tool : dat to Moon csv

Press the “Select ...” button shown in Figure 7.11 to select the file and start the conversion process.

You may also be interested in the “Excel import” instructions listed in section 7.5.1.

Tools : Comm terminal

The “Comm terminal” is a communication terminal window used for sending manual commands and viewing the response of the selected (from the found devices window) device.

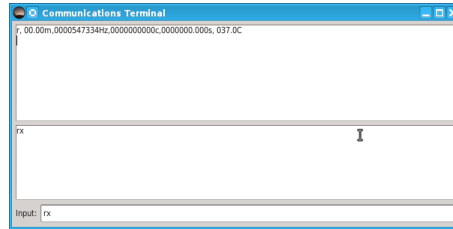

Figure 7.12: Tool : Comm terminal

Tools : DL retrieve

The “DL retrieve” tool is used for datalogging and Vector model to pull in data files that were stored on disk previously.

Tools : .dat to .kml

Creates a .kml file from a .dat file. This is used when the SQM-LU-DL-V and an external GPS are read by UDM in the Log Continuous datalogging mode.

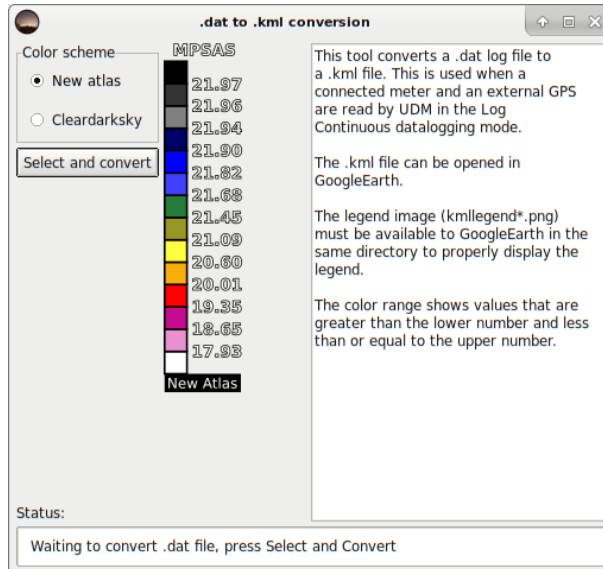

Figure 7.13: Tool : .dat to .kml

The .kml file can be imported into GoogleEarth to create an image similar to this:



Figure 7.14: Tool : .dat to .kml GoogleEarth result

This tool uses a legend image (kmllegendnewatlas.png.png or kmllegendcleardarksky.png) which must be available to GoogleEarth to properly display the legend. The resultant .kml file and legend file is stored in the “Logs directory path”.

A minimum set of data can be used by UDM to produce a map with only the MSAS brightness, Latitude,Longitude. The timestamp

The data file (with .dat extension) requires a definition line which contains at least the following fields:

UTC Date & Time,MSAS,Latitude,Longitude

A minimum example of a data file showing three data records:

Listing 7.1: .dat minimum field example

```
# UTC Date & Time,MSAS,Latitude,Longitude
2018-02-07T04:27:57.642;19.0;33.2208;-116.3387
2018-02-07T04:28:17.089;18.3;33.2208;-116.3422
2018-02-07T04:28:37.105;18.0;33.2210;-116.3457
```

The UTC Datestamp data is not used to make the .kml file, but UDM requires something there.

The format of the fields are:

YYYY-MM-DDTHH:mm:ss.fff;mag/sqarcsec;Degrees;Degrees

Tools : .dat time correction

Corrects a .dat file for out of synch timing by a manually entered offset. See figure 7.15.

This may be useful when the battery has expired in the datalogging meter, or if the clock was not set at the beginning of the datalogging session.

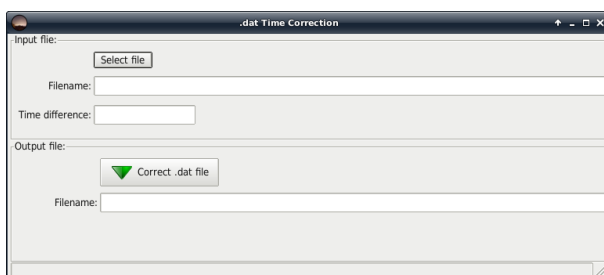

Figure 7.15: Tool : .dat time correction

Select the .dat file for correction.

Enter the manual time offset correction (in seconds).

Press the “Correct .dat file” button to write the corrected file to disk. The location of the new file is shown in the bottom Filename section.

Tools : .dat reconstruct local time

This tool is used when the datalogger timezone was not set properly. The local timestamp is recomputed for each record based on the timezone selections. One .dat file or a directory of .dat files can be corrected.

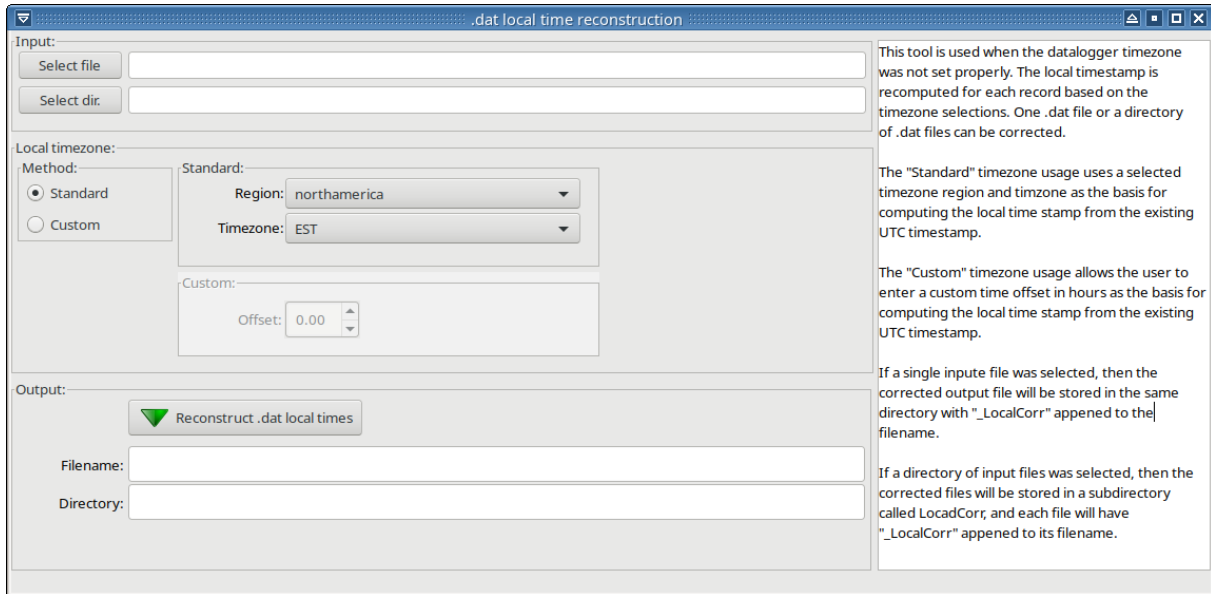

Figure 7.16: Tool : .dat local time reconstruction

Select the desired .dat file or directory of files to reconstruct.

The “Standard” timezone usage uses a selected timezone region and timzone as the basis for computing the local time stamp from the existing UTC timestamp.

The “Custom” timezone usage allows the user to enter a custom time offset in hours as the basis for computing the local time stamp from the existing UTC timestamp.

Press the “Reconstruct .dat local times” button to start the process.

If a single input file was selected, then the corrected output file will be stored in the same directory with “_LocalCorr” appended to the filename.

If a directory of input files was selected, then the corrected files will be stored in a subdirectory called LocalCorr, and each file will have “_LocalCorr” appended to its filename.

The reconstructed file(s) will be written to disk at the location specified in the bottom Filename section.

Tools : .dat time correction

If the real-time-clock inside the datalogger was not set properly or the battery was not plugged into the datalogger quickly enough to keep the super-capacitor charged before datalogging began, then there will be a difference in time when the data was retrieved. The .dat file can be corrected with this tool.

Tools : .dat to Sun-Moon-MW-Clouds .csv

Reads a .dat file of SQM data and creates a comma separated value (.csv) file with these attributes at each SQM time reading.

Table 7.4: .dat to Sun-Moon-MW-Clouds values

Label	Description
Location	Geographic name of SQM site, taken from "Location name" in raw data file; if blank the Location is printed as "Not-Specified"
Lat	Latitude of SQM, in fractional degrees, taken from Position value in raw data file; if blank, processing will stop
Long	Longitude of SQM, in fractional degrees, taken from Position value in raw data file; if blank, processing will stop
UTC_Date	Universal date extracted from raw data file "UTC Date & Time"
UTC_Time	Universal time extracted from raw data file "UTC Date & Time"
Local_Date	Local date extracted from raw data file "Local Date & Time"
Local_Time	Local time extracted from raw data file "Local Date & Time"
Celsius	Temperature of SQM, degrees Celsius, extracted from raw data file "Temperature"
Volts	Voltage of SQM, volts (battery supply), extracted from raw data file "Voltage"
Msas	SQM reading (Magnitudes per arc second squared)
Status	SQM record type
MoonPhase	Phase of the moon in degrees, 0 degrees = Full Moon; + and -180 degrees = New Moon; waxing Moon from +180 to 0 degrees: waning Moon from 0 to -180 degrees; values flip from -180 to +180 at Full Moon
MoonElev	Elevation angle in degrees of the moon above or below (negative) the local flat horizon
MoonIllum	Percentage of moon illuminated
SunElev	Elevation angle of the sun above or below (negative) the local flat horizon
MinSince3pm	Number of minutes since 3pm of the previous day; allows tracking of time from afternoon, through evening, night and morning; positive number
Msas_Avg	Average value of SQM reading during the current night, under conditions of sun lower than 18 degrees below the horizon and moon lower than 10 degrees below the horizon
NightsSince_1118	Number of nights since January 1, 2018; useful to track number of nights since that day
RightAscensionHr	Right ascension in hours of the zenith at the SQM location; equivalent to Local Siderial Time at the SQM location; used to calculate the Galactic orientation
Galactic_Lat	Angle in degrees between the zenith at the SQM location and the highest point of the Milky Way Arc; value of zero implies the SQM is pointed directly into the Milky Way
Galactic_Long	Angle in degrees from the Galactic Center (Sagittarius) eastward along the Galactic equator
J2000days	Days since January 1, 2000; fractional

Table continued on next page ...

Table 7.4 – *continued from previous page*

Label	Description
ResidStdErr	Residual Standard Error multiplied x1000; a measure of jaggedness of the SQM data over a time range specified by the user (typically 90 minutes); if RSE is large, for example > 50, then conditions can be considered to have been cloudy

ResidStdErr – some details:

Scattered clouds passing overhead cause variations in the SQM brightness readings - a plot over time under a cloudy sky tends to be very jagged. See Figures 2 and 3 of this report https://5023ce21-5614-48fc-a5d4-292b92640d50.filesusr.com/ugd/445aec_7522a23976bc472f8dbdcfb907d5d5b7.pdf by Bill Kowalik, and Michael McKeag, Oregon Chapter of International Dark-Sky Association.

ResidStdErr is a measure of the jaggedness or roughness of the SQM data over time. Large values indicate cloudy conditions. Small values represent clear conditions. You can later filter out cloudy data by only accepting data points characterized by a small RSE value.

This cloud estimation algorithm fits a linear regression to the SQM data over a time range, and calculates the Residual Standard Error (RSE), a measure of the fit between the linear regression and the actual SQM data. See Figure 7.17.

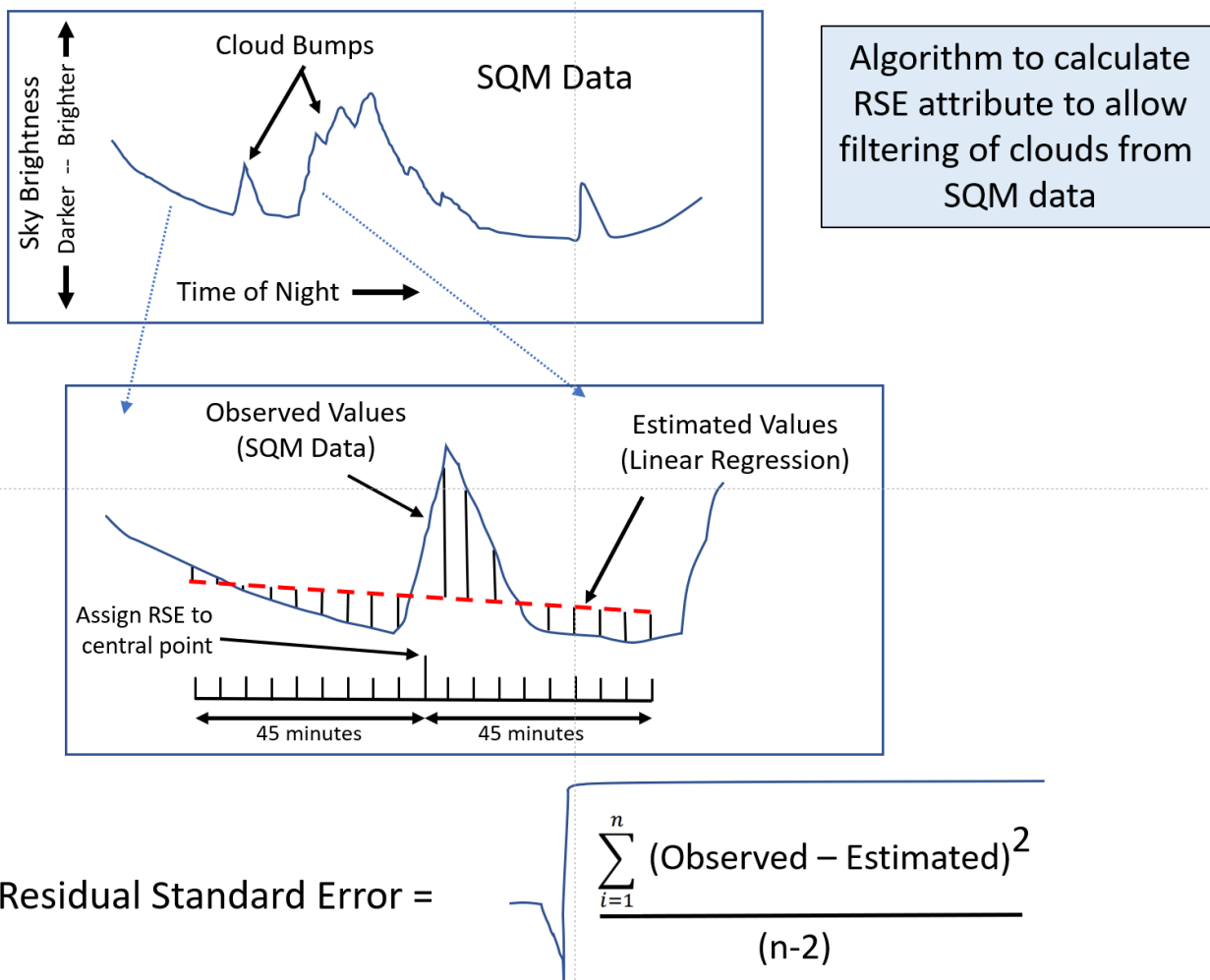

Figure 7.17: RSE algorithm

We have been using a 90-minute time span as shown in the Figure 7.17. The RSE value is assigned to the point in the middle of the time span. The time window advances one time step (typically 5 minutes in our data files) and the fit is calculated for the new center point, etc.

This algorithm processes one day of data at a time. Assuming a 5-minute sample spacing in time, there are at most 288 samples per day, so arrays are dimensioned to 300; attempts to process SQM data with time spacing that provides more than 300 samples per day will fail.

The Range parameter is the number of samples (usually 5 minutes apart) to include before and after the current point at which the Residual Standard Error of regression calculation is performed; the full width of the interval in terms of number of points to consider in the calculation is $(2 * \text{Range} + 1)$ so that a Range of 6 incorporates a time span of 60 minutes and a Range of 9 evaluates to a 90 minute span.

Additional Notes:

1. If the Latitude and Longitude are not specified in the input .dat file, processing will stop.
2. If the Location name is not specified in the input .dat file, the location name will be printed in the output .csv file as "Not-Specified".

3. A night sequence is considered to begin at 1500 Local Time.
4. The first Range number of points in a day and the final Range number of points in a day are assigned dummy RSE values of 999000.0
5. During daylight hours when the entire Range of values has SQM readings of 0.0, the RSE values is reported as 0.0

Tools : Filter Sun-Moon-MW-Clouds.csv

Reads a csv file created previously by the “UDM/Tools/.dat to sun-moon-MW-clouds.csv” program and allows you to: a) Filter that csv file for select data records and b) Apply data adjustments. For example, you can set filter parameters to find data records that were recorded during cloud-free nights. You can apply an adjustment for data recorded because the SQM was inside a weatherproof case. Data records selected by the filters are written out to two separate csv files, with keyword labels “Dense” and “Sparse”, as described below.

Parameters:

1. Sun elevation angle cutoff in degrees - includes records with sun elevation angle less than or equal to this value (default -18.)
2. Moon elevation angle cutoff in degrees - includes records with moon elevation angle less than or equal to this value (default -10.)
3. Cloud algorithm cutoff - includes records with residual standard error (cloud parameter) less than or equal to this value (default 20.)
4. Galactic Latitude elevation angle in degrees - cutoff to eliminate Milky Way from FOV, includes records with galactic latitude greater than this value (symmetric, positive and negative) (default 0.)
5. Correction for weatherproof cover – value subtracted from SQM readings to account for darkening caused by presence of weatherproof cover (default 0.11)
6. Correction for aging of the SQM - estimate of the increase of brightness reading (darkening) per year due to sunlight exposure (default 0.01897)
7. Max MPSAS allowed - includes records with MPSAS values less than or equal to this value (default 22.0)
8. Sparse cutoff – after the above filters are applied, segregates data records remaining, which are estimated to be caused by constant cloud cover, fog, smoke into the “Sparse” output file; the majority of remaining records are written to “Dense” output file; specify a larger value to segregate more data records; set to zero for no segregation in which case all remaining records go into the “Dense” output file (default 25)

Explanation of Parameters:

1. Sun elevation – a generally accepted convention is that the sun must be at least 18 degrees below the horizon to mark the beginning of astronomical darkness
2. Moon elevation – a generally accepted convention is that the moon must be at least 10 degrees below the horizon to not compromise sky brightness measurements
3. Cloud cutoff – filters on the residual standard error (RSE) attribute previously calculated by the “UDM/Tools/.dat to-sun-moon-mw-clouds.csv” program. This parameter allows the user to select skyglow measurements taken during clear, cloud-free, nights. The previously calculated RSE attribute measures the “jagginess” of the skyglow data over a relatively long time period, for example 90 minutes. If the skyglow data are relatively smooth over that time period, the sky is assumed to be clear, and the center point of that time range is considered to be a clear sky measurement. A cloud cutoff of 20 is recommended. To include more data points, use a larger cloud cutoff value.
4. Galactic Latitude – as calculated in “UDM/Tools/.dat to sun-moon-mw-clouds.csv”, the galactic latitude is defined as the angle between the zenith at the SQM location and the highest point on the galactic plane. This parameter allows the user to eliminate any records recorded when the SQM was pointing into the Milky Way. When tabulating data for certification of dark sky places, we want to eliminate any data recorded when the Milky Way was in the field of view of the SQM; that FOV is nominally 20 degrees; we suggest a 30-degree cutoff as a conservative approach. This one value is applied symmetrically on the positive and negative size of the zenith. Choose parameter value of zero to prevent exclusion of data records on the basis of the galactic latitude.

5. Correction for weatherproof cover – the presence of the weatherproof cover causes the SQM to read darker values, which yields a higher mags/arc second squared value; this correction value is subtracted from the SQM reading to account for the weatherproof cover.
6. Correction for aging of the SQM – Recent research documents that as the SQM devices age over multiple years with exposure to the sun, that there is a darkening effect on measured data – in other words, the meters read slightly darker values than they should. This parameter applies a correction to the data based on the progressive age of the SQM. The correction is absent at the beginning and increases with duration of exposure. The algorithm assumes that the first data in the SQM file was recorded when the SQM was new and that the SQM was continuously mounted outdoors to the end of the data records. The default estimate is 0.0189 magnitudes per arc second squared per year of exposure time.
7. Max MPSAS allowed – after the adjustments described above, data records higher than Max MPSAS allowed will be deleted. Cloudy night skies in areas lacking light pollution will record high values, such as 23.5 or 24.0 magnitudes per arc second squared because the clouds appear black and block the stars from view. And, these dark clouds may not be eliminated by either the cloud algorithm or the sparse algorithm (described next). It is widely believed that most clear and skyglow-free night skies will not exceed 22.0 magnitudes per arc second squared, which is the default parameter value. However, graphical inspection of your data may show that pristine night skies will show valid values of about 22.10 magnitudes per arc second squared. This cutoff ensures that unexpectedly large values are excluded from clear sky summary data.
8. Sparse cutoff – At times, the SQM will record data under night sky conditions such as constant cloud cover, fog, smoke or snow. It is desirable to eliminate these data records to avoid contamination of estimates of clear night sky summary statistics.

Because the SQM may record relatively constant values under these conditions, those SQM records will not be filtered out by the cloud algorithm, which assumes variability of data to detect cloudy conditions. The sparse cutoff parameter governs an algorithm designed to detect and segregate those relatively constant, non-clear sky data records. Choose a sparse parameter value of zero to prevent any data points going to the sparse bucket. An alternative to this automated approach is to manually delete the non-clear sky data points in some other graphical software.

After any sun, moon, Milky Way and cloud parameters are applied to filter the data, and after any data adjustments are applied, this algorithm creates an internal 2D plot of time-of-night versus SQM readings. Most of the data will overplot itself in a “dense” pattern, which is characteristic of the most commonly occurring clear sky conditions at that SQM site. SQM data recorded under nearly constant, non-clear skies (overcast, foggy etc) will occupy less dense areas of the 2D plot, either above or below the area of dense data on the plot. The goal of this algorithm is to remove those “sparse” data points by spatial filtering in that 2D plot. Figures 7.18 and 7.19 show the impact of this sparseness filter process.

The sparseness algorithm sets up an internal 2D plot in X and in Y. The X dimension is MinutesSince3pmStdTime, and ranges from 0 to 1440 minutes, divided into 5-minute-wide bins. The Y dimension is MPSAS (magnitudes/arc sec squared) and ranges from 0 to 23, divided into 0.05 mags/arc second sq tall bins.

This algorithm passes a 2D filter over the data in the 2D plot (Figure 7.20). At each occupied cell of the 2D plot, it sums the population count in 12 nearby cells, around the central target cell. If the count is small, and less than the sparseness parameter (for example, 25), it is considered to be a sparse point, and target cell data record is written out to the “Sparse” csv file. If not, the target cell data record is written out to the “Dense” csv file.

As shown in Figure 7.20, the 12 nearby cells are seven cells tall with a central 3x3 area, excluding the target cell. The blank point in the middle of the filter is the target point. The area processed is taller than is wide because the sparse points tend to have blank areas above them in the XY scattergram. The tall pattern is designed to successfully identify the sparse points.

This program creates three output files:

1. A csv file of the selected data records labelled “Dense” this file contains those data records which pass the sun, moon, cloud, Milky Way, max MPSAS allowed and sparse cutoff filters - i.e. “dense” data which represents the most commonly occurring data at an SQM site; this file has the same format as the input .csv file

2. A csv file of the selected data records labelled “Sparse” which pass the sun, moon, cloud, milky way and max MPSAS allowed, but which are segregated by the sparse cutoff test - these are the scattered data points which passed the cloud removal filter, but which are probably caused by constant cloud cover, fog, snowy conditions, etc.; this file also has the same format as the input csv file
3. A text file that lists the parameter values and summary statistics for the filtered data. After the filtering for sun, moon, MW and clouds, and applying any corrections specified, the text file lists the mean, min and max of the selected data points. This is a summary of the combined records of the “Dense” and “Sparse” output files.

And, after filtering out any sparse points, the text file lists the mean, min and max again. This is a summary of the records in the “Dense” output file. If parameters are chosen well, this is a summary estimate of the brightness of the night clear sky data recorded by the SQM.

For quality control, it is good practice to graphically display both the “Dense” and the “Sparse” csv files. Graphical display allows you to understand the implications of your parameter choices. For example, you may want to change the cloud cutoff value to exclude more records or the sparse cutoff value because too many, or too few, of the data points were assigned to the sparse bucket.

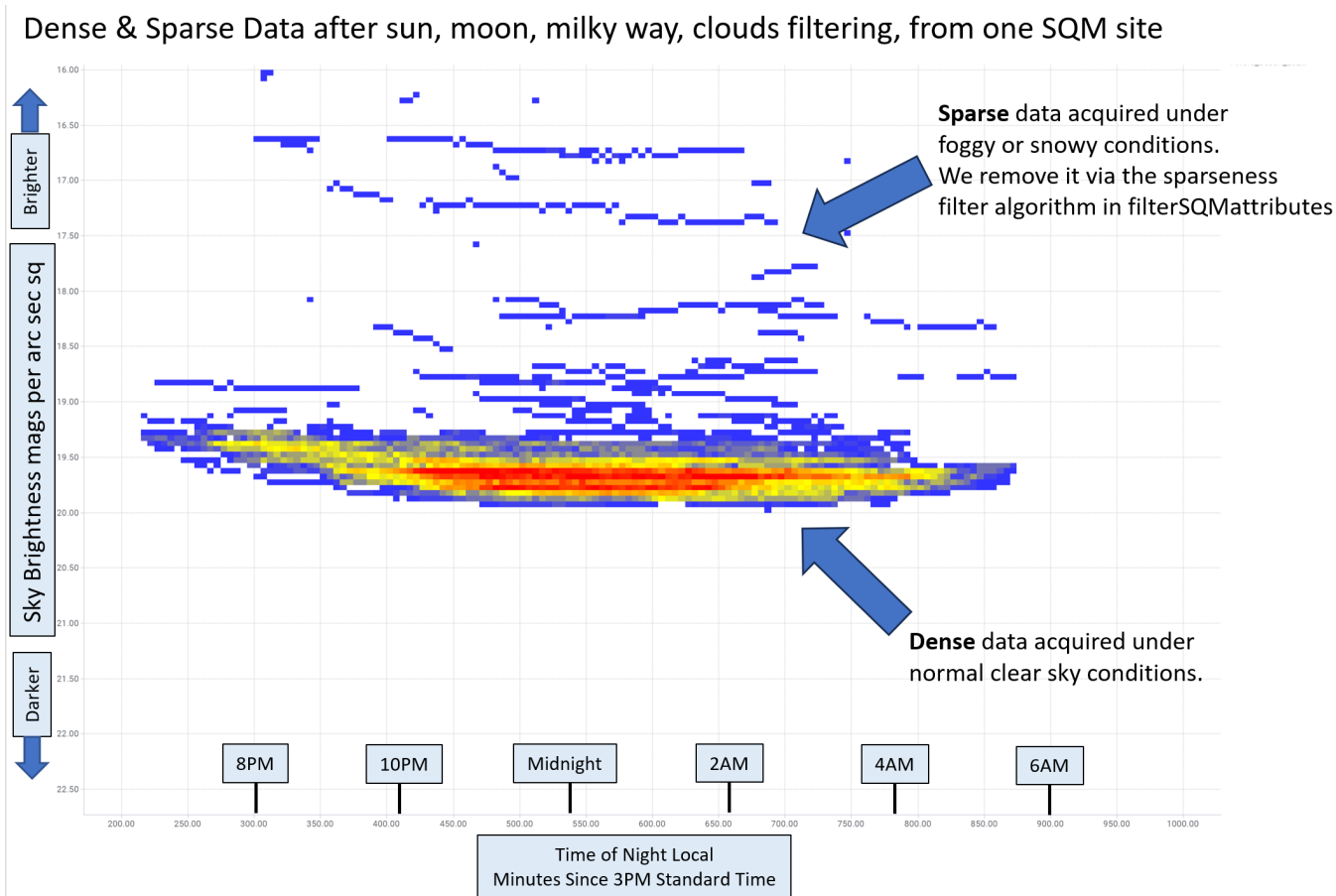

Figure 7.18: Several years of data from one SQM site summarized in a 2D plot, after filtering for sun, moon, Milky Way and clouds. Colors are proportional to the number of data points at each cell of the plot. Red represents most frequent points, blue least frequent. The goal of the sparseness filter is to remove the data points that plot away from the most dense data, to avoid bias of measurement of the clear night sky brightness. See Figure 7.19

Dense Data after sun, moon, milky way, clouds, sparseness filtering, from one SQM site

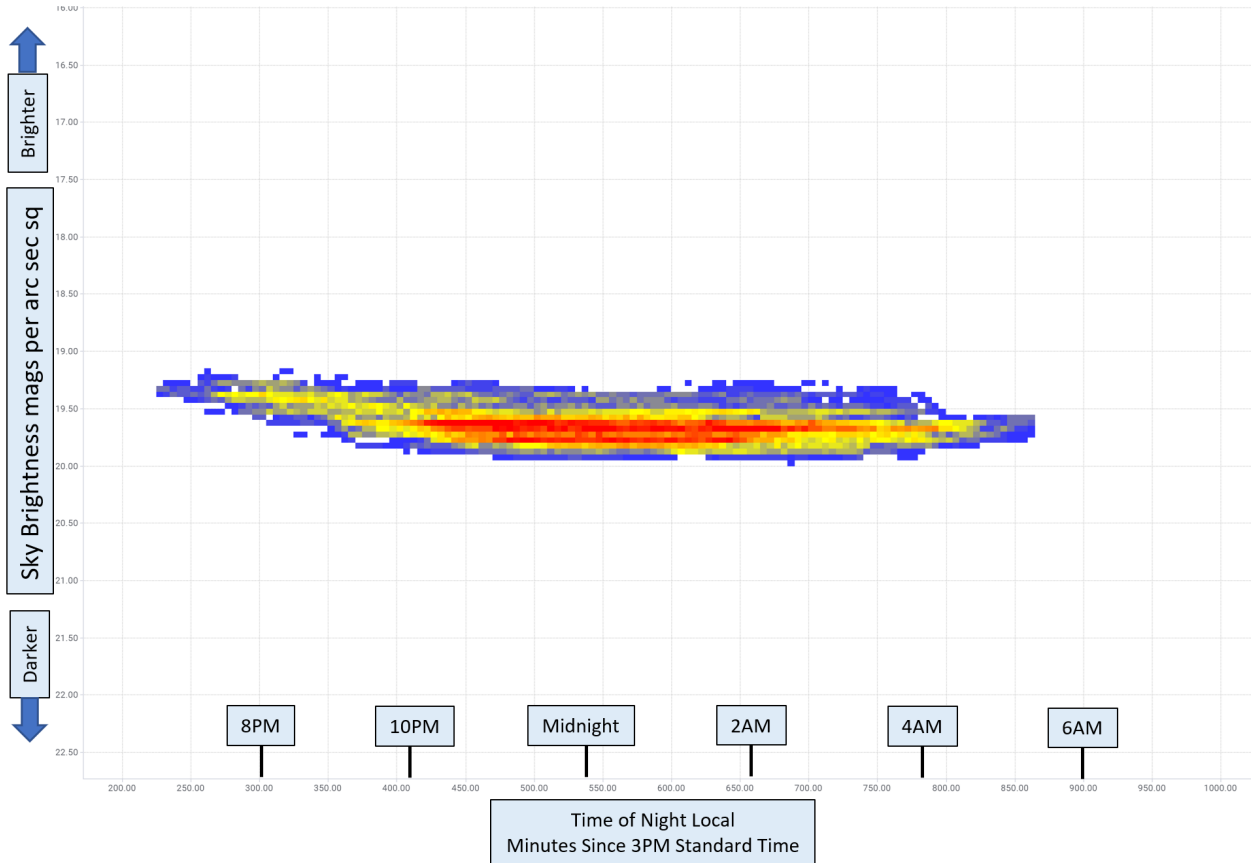

Figure 7.19: Same data as Figure 7.18, but after application of the sparseness filter. The remaining data can provide a good estimate of the night sky brightness at this SQM location.

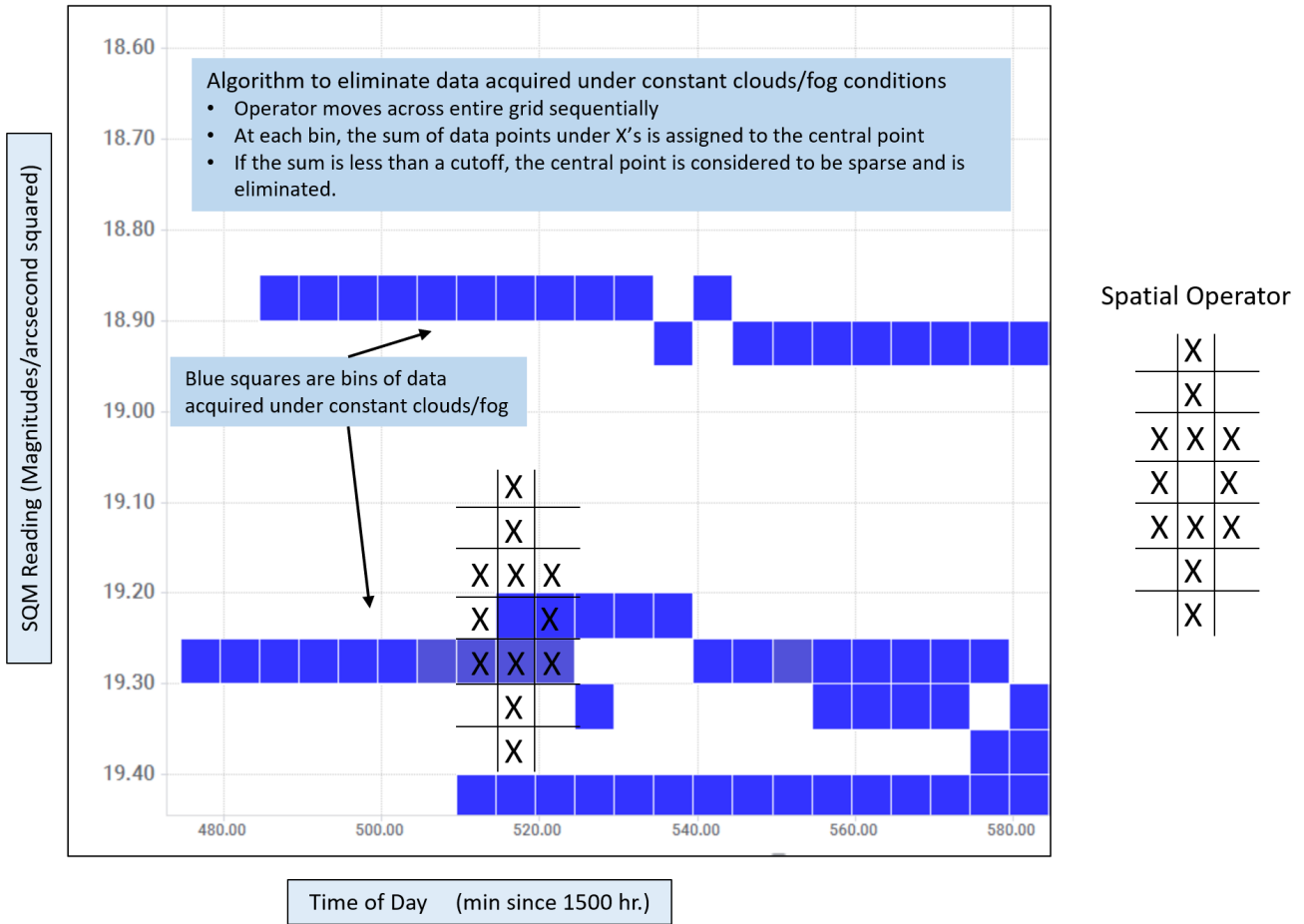

Figure 7.20: Diagram of the sparseness filter. Blue squares represent SQM measurements acquired under infrequent overcast or foggy conditions. The goal of the sparseness algorithm is to identify them for segregation into the “Sparse” output csv file.

7.3.7 Help menu

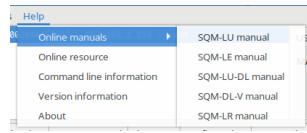

Figure 7.21: Help menu

Help : Online manuals shows online links to the meter manuals. Click on the desired meter to open that PDF manual in your browser.

Help : Online resource links to the updated online Unihedron resource files that are sent out with each meter.

Help : Cmdline Info shows the commands that can be used when starting UDM from the command line.

Help : Version Info shows the detailed version information for the UDM software.

Help : About displays a simple screen with the version identifier.

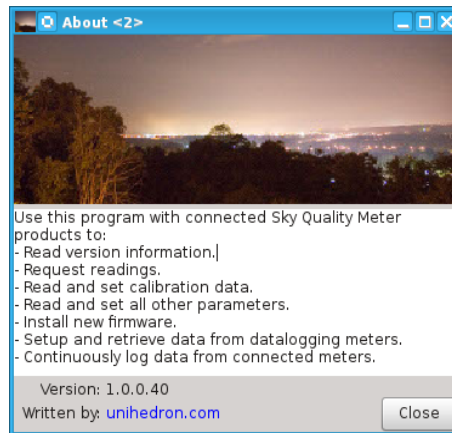

Figure 7.22: Help : About

Found devices box shows all the connected SQMs available that UDM can find from this computer.

If only one device is found, then UDM auto-selects it and gathers the version information for that selected device.

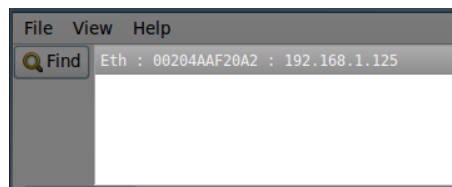

Figure 7.23: Found device (single)

If more than one device is found, then UDM does not select any of the devices. You may select the desired device by clicking in the found devices box on the SQM that you want to know more about. Once you select the device, then the

connection details are displayed. Clicking on the “Version” or “Reading” button will gather more information from the meter.



Figure 7.24: Found device (multiple)

Device details shows the connection details of the selected SQM listed in the “Found devices” box.

The USB “Port” field is editable so you may enter your own port that might not be defined in the found box. See Figure 7.25.



Figure 7.25: USB connection details

The Ethernet IP and port fields are editable so you may enter your own IP and port that might not be defined in the found box. The default port number for the SQM-LE is 10001. See Figure 7.26.



Figure 7.26: Ethernet connection details

The RS232 fields are editable so you may enter your own port and baud rate. The baud rate for the SQM-LR is 115200. See Figure 7.27.



Figure 7.27: RS232 connection details

7.4 Information tab

The information tab is used to show information about the version and the reading of the selected SQM.

Press the “Version” button for an updated list of data about the device version, and press the “Reading button” for an updated list of data about the device reading.

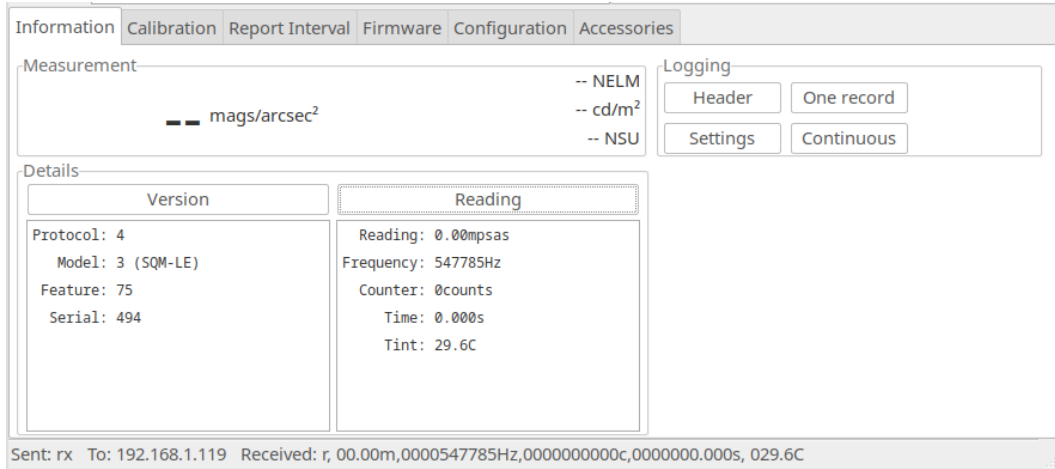

Figure 7.28: Information tab

The Header button calls up the data file header entry screen, see the datalogging Header section on page 32 for more information. This header information is used when storing logged data to the disk with the “Log one record” or “Log continuous” functions described below.

Log one record gathers one data record from the connected SQM and stores that information to a data log file on the disk in the “Logs directory path”. The location of the file can be identified and changed by “View : Directories”. The log file can be accessed later from the “File : Open” menu.

7.5 Log Continuous

The “Log continuous” function allows data from the connected SQM device to be logged repetitively as shown in Figure 7.29.

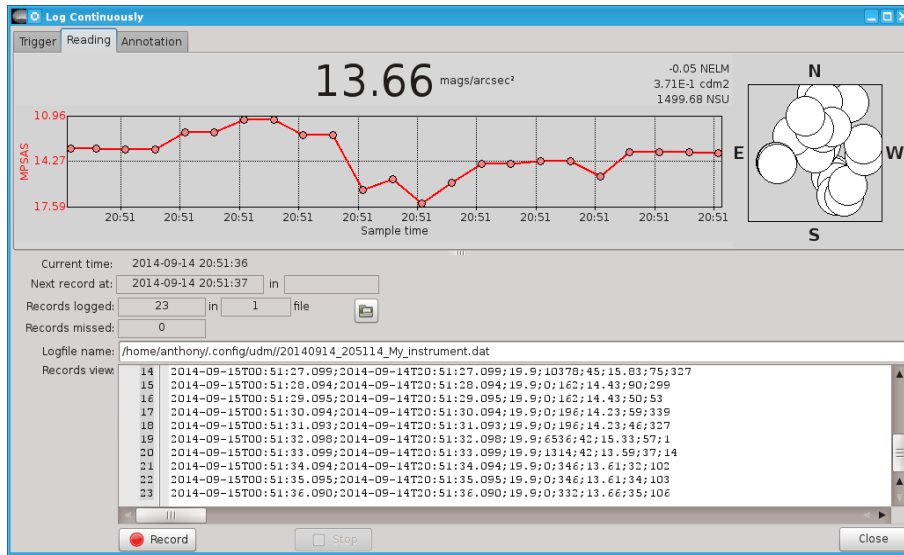

Figure 7.29: Log Continuously screen

Log Continuous Trigger options must be defined before logging, see Figure 7.30 for possibilities:

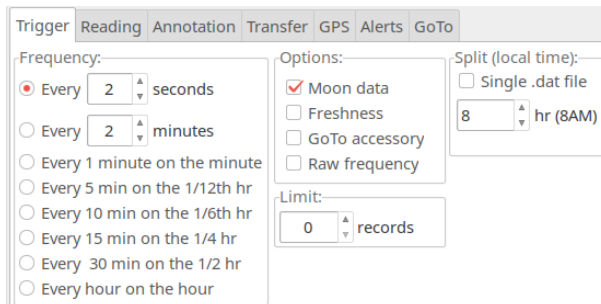

Figure 7.30: Log Continuously Trigger tab



Figure 7.31: Log Continuously Look tab

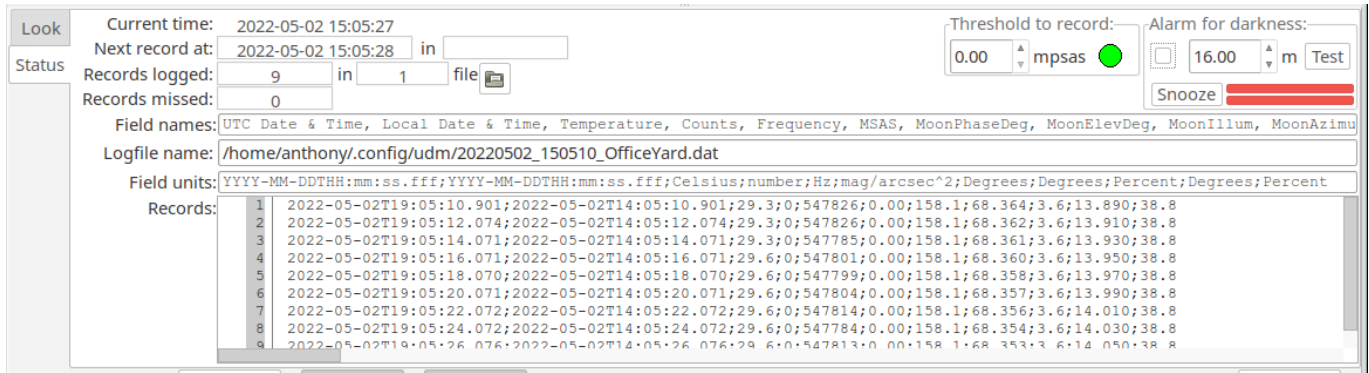

Figure 7.32: Log Continuously Status tab

To operate the continuous logging function:

1. Select the frequency of logging from the trigger tab.
2. Select if “Moon data” is to be computed and logged.
3. Select “Freshness” to identify Fresh/Stale results. This is useful when recording brightness from a moving platform, specifically.
4. Enter “Split (local time)” to adjust the starting time of the recorded .dat file. The default is at 0 (midnight), but you can set that to 12 to have the night time readings centered in the .dat file and plot views.
5. Select “Single .dat file” to prevent separate daily files being created each 24 hours.
6. Select “GoTo accessory” when the meter is mounted on a GoTo tripod and direction commands come from the GoTo tab.
7. Select “Raw frequency” when the rFx command is desired which send the linear raw light reading frequency. (Firmware 75 and above).
8. Select a limit to the number of records. A value of zero is default and means there is no limit. Any other value 1-1000 means that UDM will stop recording after that many records have been taken.
9. Press the “Record” button. The records are stored in a logfile whose location is shown in the “Logfile name” area. A new logfile is automatically created at the beginning of each day (at local time 0:00).
10. Press the “Stop” button when you want to stop the recording process.
11. Log files can be accessed by the “File : Open” menu selection or by pressing the “folder” button shown in the “Log Continuously” screen.
12. Press “Close” when done with the continuous logging feature.

Threshold to record A threshold for recording readings can be set before starting recording. Any reading greater or equal to this threshold value will be recorded in the log file.

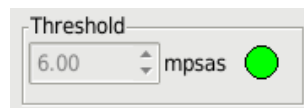

Figure 7.33: Log Continuously Threshold

A threshold of 0 will allow all readings to be recorded.

The threshold indicator will turn green if the threshold of the triggered reading is met (recording) and red if the triggered reading is below the threshold (no recording).

The threshold value is saved in the registry configuration file when it is changed. Changes can only be made while not recording.

An override from the command line options (-LC_{TH,x}) can be made. The override will only take effect for the current session and will not alter the saved configuration.

Audio alerts In cases where you want to be alerted that a reading will be taken, for example, when manually pointing the meter, the Pre-reading audio alert named `prereading.wav` can be enabled as shown in (Fig. 7.34) to play an audio file two seconds before the light meter record is logged. The “Test” button plays this file for test purposes.

Also, an optional reading alert sound file named `freshreading.wav` can also be played exactly when the reading has been gathered by selecting an option from the reading alert box. By selecting “Fresh only”, the sound is only played when the meter gathers a “Fresh” reading (Fresh readings are defined in the Light measurement section 3.1). By selecting “All”, the sound is played after every light meter reading has been recorded.

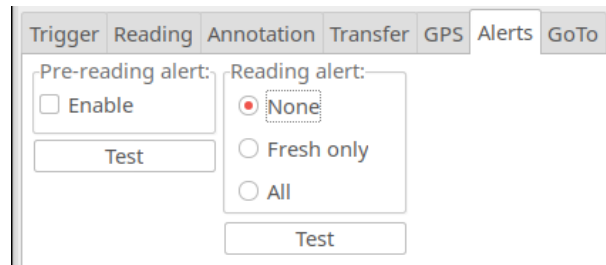

Figure 7.34: Log Continuously alerts

The audio files are located in the Data Directory (which can be identified from the main page [View→Directories](#)).

Alarm for darkness When the darkness is over the threshold amount, an audio file can be enabled to play (Fig. 7.35) . The Test button plays this file for test purposes. The audio file is named `alarmsound.wav` and is located in the the Data Directory (which can be identified from the main page [View→Directories](#)).

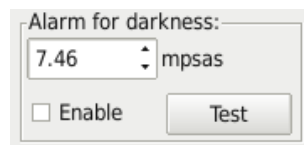

Figure 7.35: Log Continuously Alarm for darkness

Transfer reading Each reading can be sent by TCP to an external destination (remote) server.

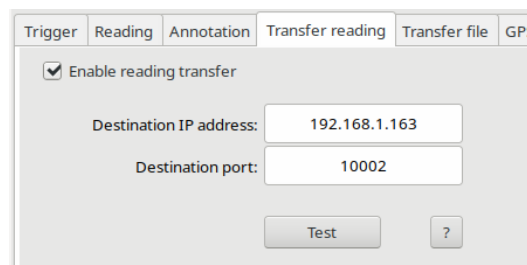

Figure 7.36: Log Continuously Transfer reading

To set up this feature:

1. Enter the IP address of the destination server.
2. Enter the port of the destination server.
3. Check the Enable box.
4. Start logging.

The TEST button is available to check if the reading packet can be sent to the destination server.

To send data to the Globe at Night server:

- Make an email request to globeatnight.network@gmail.com
- Provide your GPS location.
- Provide your City/State/Country.
- Provide your serial number.
- Ask them for the IP address and Port number.
- Double check with them at a later date that your readings have been received.

An example packet which contains the reading and the serial number (Rx reading response) looks like this:
`r, 00.00m,0000547954Hz,0000000000c,0000000.000s, 022.8C,00000494`

Transfer file The .dat file can be sent via FTP, SCP, or SFTP to a server by making settings on the left side of the Transfer tab (shown in Fig. 7.37)

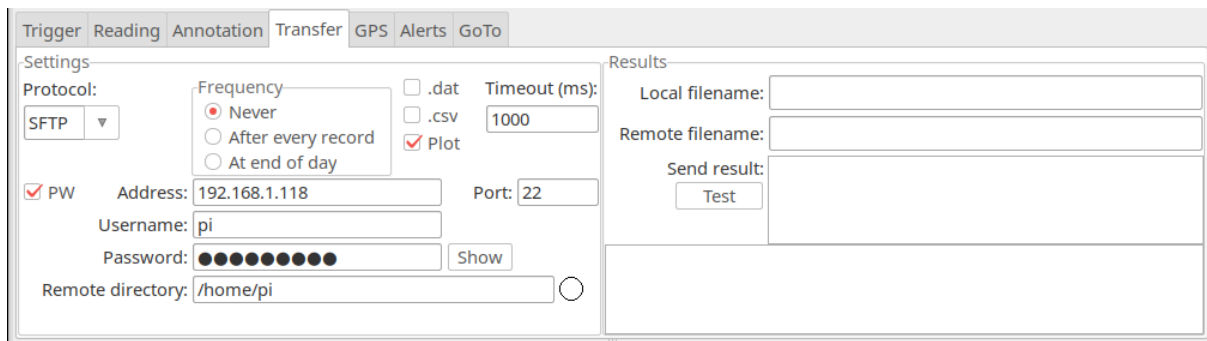

Figure 7.37: Log Continuously Transfer tab

The following transfer protocols files is available:

- **FTP** (File transfer protocol).
- **SCP** (Secure file Copy) transfers require that the `scp` command exists externally from UDM. For Linux and Mac, the `scp` command is `scp` and can be proven to exist with the `which scp` command. In Windows, if you do not have access to `scp`, you may have to install a program called `pscp` and rename it to `scp`. Make sure that the SSH connection from the UDM machine to the remote machine can be opened without a password. You will have to copy the public key etc. to make a passwordless connection.
- **SFTP** (Secure File Transfer Protocol) assumes that the `sftp` command exists. This is not available for Windows at this time.

Files will be sent to the server using one or more of the following options:

- **.dat** sends the date-named .dat file which contains recorded readings.
- **.csv** sends the date-named .csv file which contains recorded readings in comma separated variable format.
- **Plot** sends the daily plot and an html file that can be used to display on a web server (details below)

Timeout (ms): tells UDM how long to wait before giving up on the transfer. When all is working well, a value of 1000ms (one second) should be sufficient.

The **Results** box shows some testing diagnostics.

The **Local filename:** is the path and file name that will be transferred to the remote server.

The **Remote filename:** shows the path and name of the file that should be sent to the remote server.

The **Test** button will initiate a transfer for testing the settings were results are shown on the screen beside and below the **Test** button.

When the **Plot** option is selected, UDM fills in the sqm-template.html file in the data directory with reading and date variables, then sends the resulting filled-in information as sqm.html to the server. A date-named plot file is also sent (its name is defined as startdate.png and encoded inside sqm.html in the imagename variable described below).

The possible variables that you can use in the sqm-template.html are:

- `<!-- SQM-location -->` The location name taken from the associated header entry.
- `<!-- SQM-coordinates -->` The GPS coordinates taken from the associated header entry.
- `<!-- SQM-timestamp -->` The timestamp of the current reading.
- `<!-- SQM-nexttimestamp -->` The timestamp of the next reading.
- `<!-- SQM-mpsas -->` The current reading in mpsas.
- `<!-- SQM-nelm -->` The current reading in mpsas.
- `<!-- SQM-cdm2 -->` The current reading in mpsas.
- `<!-- SQM-mcdm2 -->` The current reading in mpsas.
- `<!-- SQM-NSU -->` The current reading in Natural Sky Units.
- `<!-- SQM-Best -->` The best reading of the plot in mpsas.
- `<!-- SQM-BestTime -->` The time that the best reading was recorded.
- `<!-- SQM-imagename -->` The filename of the plot file, will be something like 20220501.png.

Each variable must be on its own separate line in the sqm-template.html file, and the variable must start at the beginning of the line. See the sqm-skeleton.html file for an example. If the sqm-template.html does not exist after initial installation, then it is created from a copy of sqm-skeleton.html file located in the initial program installation directory

Annotation settings While the “Log Continuous” mode is recording data, annotations can be made to the log file records with hotkeys. The Annotation tab allows the definition of hotkeys and their associated annotation text that will appear at the end of an annotated record.

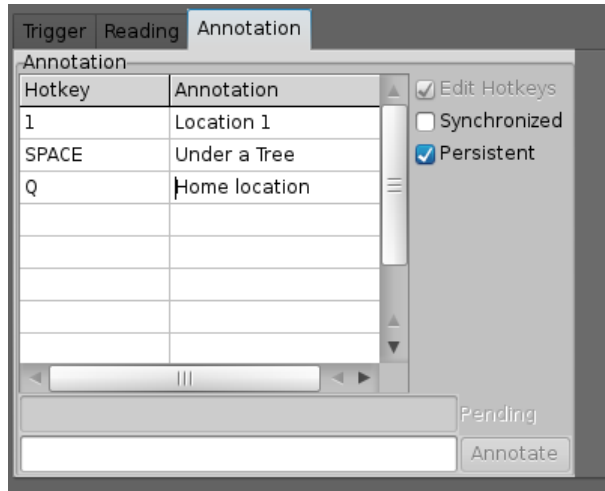

Figure 7.38: Log Continuously Annotation tab

Persistent annotation The “Persistent” mode makes the annotated text persistently appear at the end of each logged record after the first time the hotkey is pressed.

Without “Persistent” checked, annotation text is only appended to a record when the hotkey is pressed, and other records have no annotation text.

Synchronized annotation The “Synchronized” mode postpones annotation requests until the next scheduled record so that the annotated text is synchronized with scheduled triggered recordings.

Without “Synchronized” checked, the hotkey will immediately trigger a record log, and the associated annotation text will be appended to that triggered record.

GPS UDM will read the data produced from an externally connected USB or serial GPS receiver like the GlobalSat BU-353 GPS. Also the Bluetooth GPS Dual XGPS160 has been test on a Mac.

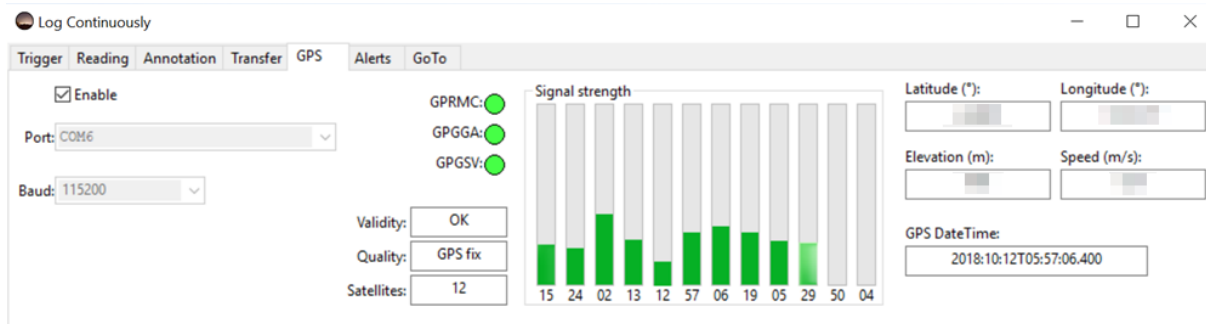

Figure 7.39: Log Continuously GPS tab

The following GPS units have been tested with the latest UDM software:

GPS	Connection	Settings
GlobalSat BU-353	USB	4800 baud
GlobalSat BU-353 S4 (5Hz)	USB	115200 baud
Dual XGPS160	Bluetooth	See GPS owners manual

Enter the communications port name (see below) into the Port field, the baud rate into the baud field, then enable the GPS. Once enabled, UDM continuously scans the GPS port for three NMEA words.

GPS on Windows 10 To get the Communications Port for a USB connected GPS to a Windows 10 computer:

1. Click Start → Settings → Devices → Connected-devices
2. The GPS should show up there as "Prolific USB-to-Serial Comm Port (COMx)". note which Comm port is listed, one example is COM6 GlobalSat BU-353 S4 (5Hz)
3. Make sure that no other programs are accessing the GPS.
4. Start up UDM, make sure you meter is selected
5. Select Log Continuous → GPS-tab
6. Enter the Comm Port into the Port: field, in my case I just typed in COM6
7. Enter the baud rate for the GPS into the Baud: field, in my case I just typed in 115200

GPS on Mac To get the Communications Port for a USB connected GPS to a Mac computer:

1. Follow the instructions for driver installation on the CD provided with the GPS
2. Connect the GPS
3. Open a terminal window
4. Type in: `ls -altr /dev/*` to look for the most recently created file that looks something like `cu.usbserial`
5. The newly connected GPS is located at something like `/dev/cu.usbserial`
6. Make sure that no other programs are accessing the GPS.
7. In UDM → Log-continuous → GPS → Port:, type in that filename. An example would be: `/dev/cu.usbserial`
8. Enter the baud rate for the GPS into the Baud: field, in my case I just typed in 115200

GPS and SQM startup procedure Some computers reassign the communications port at power up or re-connection, so to ensure that the UDM can recognize both the SQM and the GPS, please follow these steps:

1. Disconnect the SQM and GPS from computer before powering up.
2. Power up the computer.
3. Start up UDM.
4. Connect the SQM and ensure you get a reading.
5. Disable the GPS connectivity from the log continuous tab.
6. Connect the GPS, and under the Log Continuous GPS tab ensure you are getting GPS location data.
7. Carry on from there.

GPS status Upon successful parsing of the GPS data, UDM illuminates (with bright green) the associated indicators (GPRMC, GPGGA, GPGSV). If too much time passes, the indicators fade to black.

The signal strength group shows the signal to noise ratio (SNR) for all visible satellites. The satellite number is displayed below each signal strength meter.

The location, speed, time, and status information is displayed as it is received.

If the GPS is enabled before logging, then the logfile is forced to "MOVING" platform mode, and five fields (latitude, longitude, elevation, speed, number of satellites in view) are appended to each record.

GoTo A GoTo pointing device accessory can be controlled by UDM for the purpose of pointing the meter to various parts of the sky and automatically gathering a reading at each position.

The following GoTo devices are currently supported:

- SynScan V4
- iOptron 8408

The connection of the GoTo device is made to the serial port. Note; some USB to RS232 serial adapters do not act properly with UDM. Usually an FTDI adapter should work well.

Select the machine type, port, and baud rate. Ensure that the connected device is actually available on the port you select. In Windows, you can use the Device manager, In Mac and Linux, you can type **dmesg** on the command line in a terminal window to see the latest USB device attached.

A script file containing the positions is located in the “Data Directory” which is identified by:
View→Directories→Data_Directory.

On a Mac, you can use Finder to go to “Applications”, then right click on “udm” or “udm.app” then select “Show contents”. Then you can navigate to Contents→Resources to see the location of the *.goto file(s).

The format of the GoTo script file is a semicolon-separated file with an extension of “.goto”. Comment lines are preceded by the pound symbol (#). The second line defines the field format (Zenith;Azimuth). The remaining lines define the points to move to. An example is:

```
# Default
# Zenith;Azimuth
0;0
15;0
15;60
15;120
```

Control of the positioning is done from the trigger page. The “Goto accessory” and “Freshness” check boxes must be set. Pressing the “Record” button will start the pointing sequence.

7.5.1 Import.dat into spreadsheet

The .dat file generated by UDM can be imported into a Microsoft Excel spreadsheet for calculations and graphing purposes as follows:

1. Start excel
2. File Open
3. Select “All files”
4. Select your .dat file (previously recorded and saved).
5. Select “delimited” (as opposed to the default “fixed width”)
6. Import starting at line 33
7. Next
8. Unselect “Tab”
9. Select “Semicolon”, you should see bars separating the data fields now.
10. Next
11. Define each field. European users will have to select “Advanced”, then change the “Decimal point” to “.” and “Thousands separator” to “,”
12. field 1,2 = date YMD

Note: You can also use the “.dat to Moon .csv” tool shown in Fig. 7.11 to create a comma separated variable file for importing into a spreadsheet like Excel.

7.6 Calibration tab

The Calibration tab is used to show and set the calibration data for the selected SQM device.

The screenshot shows the Calibration tab selected in a menu bar. Below the menu are two buttons: "Get Calibration Info" and "Log Calibration Info". The main area contains a table with two columns: "Desired Values" and "Actual Values".

	Desired Values		Actual Values	
Light Calibration Offset:	<input type="text"/>	Set	<input type="text"/>	mpsas
Light Calibration Temperature:	<input type="text"/>	Set	<input type="text"/>	°C
Dark Calibration Period:	<input type="text"/>	Set	<input type="text"/>	s
Dark Calibration Temperature:	<input type="text"/>	Set	<input type="text"/>	°C

Notes:

- See calibration sheet for original settings.
- Add/subtract Light Cal offset for extra glass covering.
- Temperature values get reconverted, so the actual may be slightly different than the desired.

Figure 7.40: Calibration tab (initial)

Press the “Get Calibration Info” button so that the updated calibration data is brought in from the SQM on to the Actual values boxes as show below.

The screenshot shows the Calibration tab selected in a menu bar. Below the menu are two buttons: "Get Calibration Info" and "Log Calibration Info". The main area contains a table with two columns: "Desired Values" and "Actual Values".

	Desired Values		Actual Values	
Light Calibration Offset:	<input type="text"/>	Set	19.73	mpsas
Light Calibration Temperature:	<input type="text"/>	Set	24.8	°C
Dark Calibration Period:	<input type="text"/>	Set	170.150	s
Dark Calibration Temperature:	<input type="text"/>	Set	26.4	°C

Notes:

- See calibration sheet for original settings.
- Add/subtract Light Cal offset for extra glass covering.
- Temperature values get reconverted, so the actual may be slightly different than the desired.

Figure 7.41: Calibration tab (populated)

Use the following steps to change the calibration values:

1. Enter the new calibration data on the left side entry box (Desired values column).
2. Press the associated “Set” button.
3. The value is sent to the SQM, and then confirmed in the right side box (Actual values column).

Note that temperatures set in to the SQM use their own resolution and may not be reflected as the same value entered. For example. 24.7°C might read back as 24.8 °C.

The original factory calibration values were provided on a paper with the shipped unit. If you have lost this information, please contact Unihedron to have the information emailed.

7.7 Report Interval tab

The Report Interval tab is used to show and set the report interval information for the selected SQM. Report interval settings are used to control the SQM to send readings out at a regular rate (in seconds) and only if darker than a specified threshold value. See section 8.8 on page 106 for more information about “Interval reporting”.

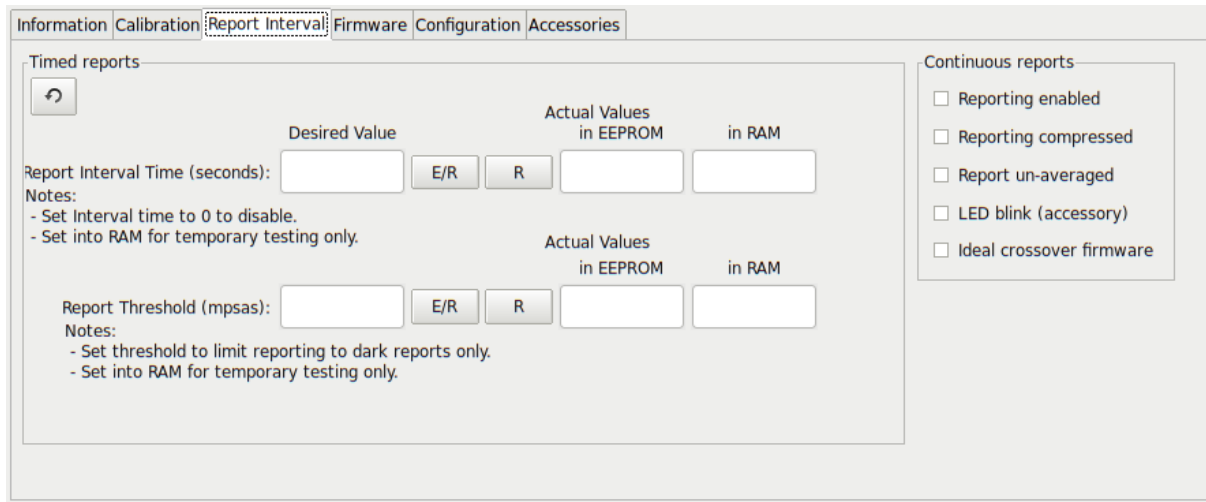

Figure 7.42: Report interval tab

Use the “R” button to temporarily set the value in to RAM for experimentation. The new value will be used instantly. The RAM value is set to the EEPROM value on power-up.

Use the “E/R” button to set the value in to EEPROM and RAM. The new value will be used instantly and also after power up.

Report interval is measured in seconds (i.e. 300 = 5 minutes).

Report threshold is measured in Magnitudes per square arcsecond (mpsas), a larger positive value is darker.

7.7.1 Continuous reports

The Continuous reports section enables special features related to reporting through an optionally installed I2C interface except for the Ideal crossover function selection.

Reporting enabled: The readings are sent to the I2C adapter as they are computed.

Reporting compressed: High speed reporting is sent out in a compressed format.

Report un-averaged: Send only the unaveraged readings to the I2C device.

LED blink accessory: Enables the LED on the DL models to blink each time a reading is gathered.

Ideal crossover firmware: See Theory of operation section 3.1 for full details.

7.8 Firmware tab

In a case where new firmware is supplied by Unihedron to correct bugs or add features, use this tab to select and load firmware in to the SQM-LU-DL-V.

All available versions of firmware are shipped with the UDM software package in case you want to revert to an earlier firmware version for testing purposes. New firmware versions are announced on the Unihedron forum.

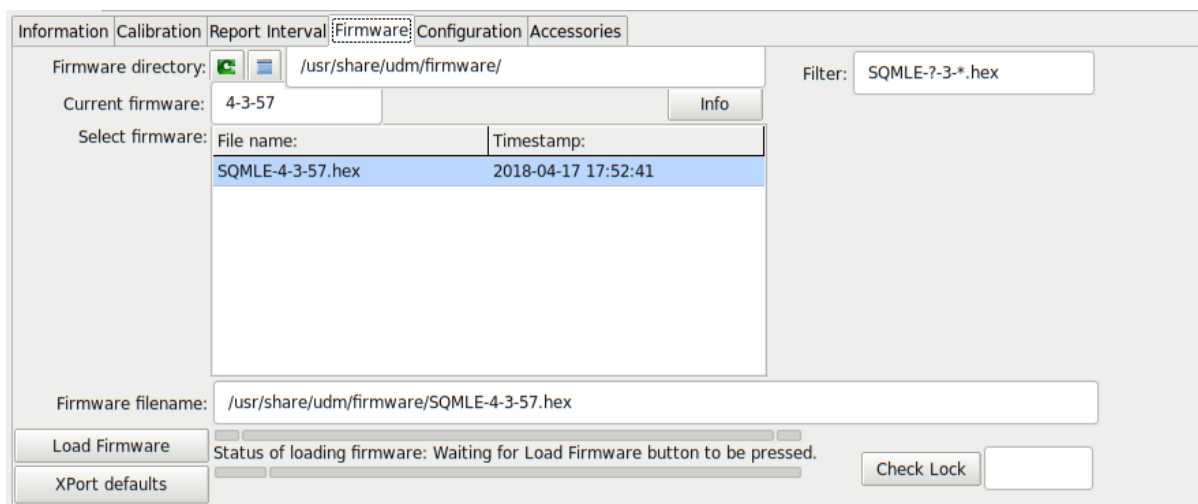

Figure 7.43: Firmware tab

Follow these steps to load new firmware:

1. Press the “Select Firmware” button to choose the firmware file to load into the SQM as shown in Figure 7.44:

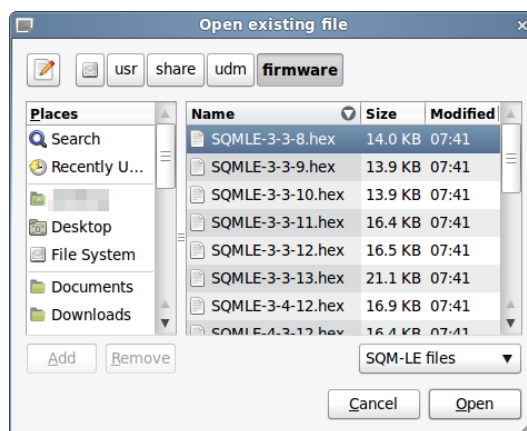

Figure 7.44: Firmware selection

2. Select the desired firmware file then press “Open”.
3. The “Load firmware” button will be enabled and you can press it now to start loading the firmware into the SQM-LU-DL-V. The status bar will indicate successful completion when the firmware has been completely loaded.

When using a Mac or Linux, the firmware can be loaded/restored using the “USB comm check” method when the associated buttons appear. The steps are shown as follows:

1. Start UDM
2. Have the meter connected
3. Go to the firmware tab
4. Select the appropriate firmware like SQM-LU-DL-4-6.67.hex
5. Press the "START UNPLUG METHOD" button
6. Follow the instructions shown on the right side of the button.

7.9 Data Logging tab

The “Data Logging” tab is available when an SQM-LU-DL-V unit is connected and selected.

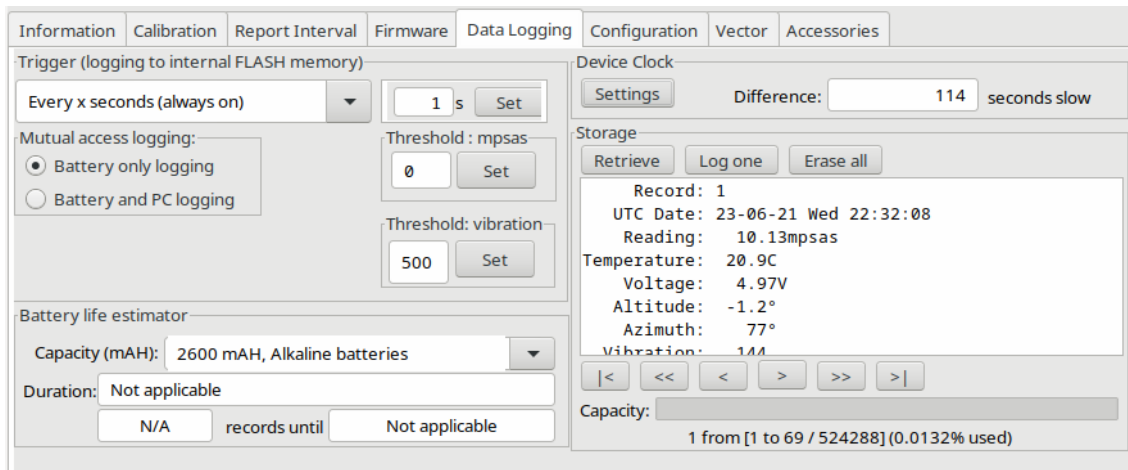

Figure 7.45: Data logging tab

Trigger group Select one of the items in the trigger group to define when the SQM-LU-DL-V will record data while connected to a battery instead of connected to the computer.

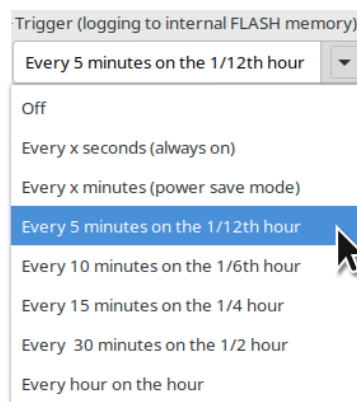

Figure 7.46: Data logging trigger selection

Mutual access logging The default, “Battery only logging” mode allows triggered logging while connected to the battery pack where there are no data wires (only power wires) connected to the USB jack. In this mode, the SQM-LU-DL-V will not log readings to its internal FLASH memory while connected to the PC.

The “Battery and PC logging” mode allows triggered logging while connected to the battery pack or the PC where there are data wires connected to the USB jack. In this mode, the SQM-LU-DL-V will log readings to its internal FLASH memory while connected to the PC. This feature currently only works with “Ideal crossover firmware” checked on the “Report Interval” tab.

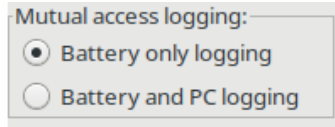

Figure 7.47: Data logging: Mutual access logging selection

Threshold : mpsas Readings darker than the threshold value (mpsas) will be recorded. Readings brighter (lower value) than the threshold value will be ignored. The SQM-LU-DL-V still has to turn on to determine the brightness value.

Threshold : vibration Readings will only be recorded when the meter is vibrating less than the threshold setting. The SQM-LU-DL-V still has to turn on to determine the vibration level.

Battery Life estimator Use the “Battery life estimator” to determine the approximate battery life with the selected trigger settings.

A custom mAH value may be entered directly into the “Capacity” field to instantly show a calculated duration approximation.

Device Clock To set the RTC on the SQM-LU-DL-V, press the “Device Clock” button to call up the “Real Time Clock” dialog. While the RTC dialog is shown, UDM continuously polls the SQM-LU-DL-V for an updated Unit clock value. The UTC and local time are taken from the computer that UDM is running on.

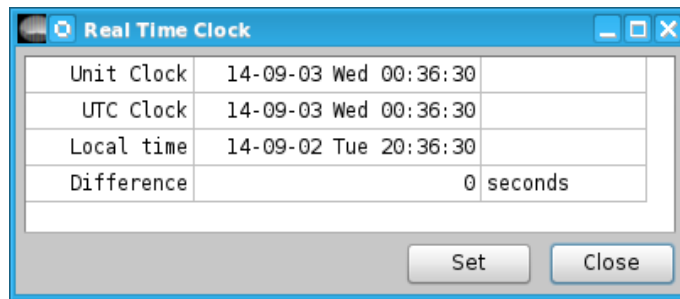

Figure 7.48: Real Time Clock setting dialog

Pressing the “Set” button will copy the UTC time in to the SQM-LU-DL-V. Due to single second resolution, the clocks may never match within 0 seconds difference. The SQM-LU-DL-V clock is as accurate as a common digital watch, it may drift a few seconds per day.







Storage The “Storage” section shows the contents of the SQM-LU-DL data-logging memory.

The position buttons shown below are used to move through the data-logger memory and view individual records:



Figure 7.49: Storage navigation

Table 7.5: Storage navigation button descriptions

Button	Description
	Move the current record pointer to the first record stored in the SQM-LU-DL-V and display that record.
	Move the current record pointer back 10 percent of the total records and display that record. Does nothing if already displaying the first record.
	Move the current record pointer back one position and display that record. Does nothing if already displaying the first record.
	Move the current record pointer forward one position and display that record. Does nothing if already displaying the last record.
	Move the current record pointer forward 10 percent of the total records and display that record. Does nothing if already displaying the last record.
	Move the current record pointer to the first record stored in the SQM-LU-DL-V and display that record. Note that if the meter is still recording values, the last position will be increasing, so continued presses of this button may result in the display of new records.

Retrieve Press the “Retrieve” button to call up the “Retrieve” dialog shown in Figure 7.50.

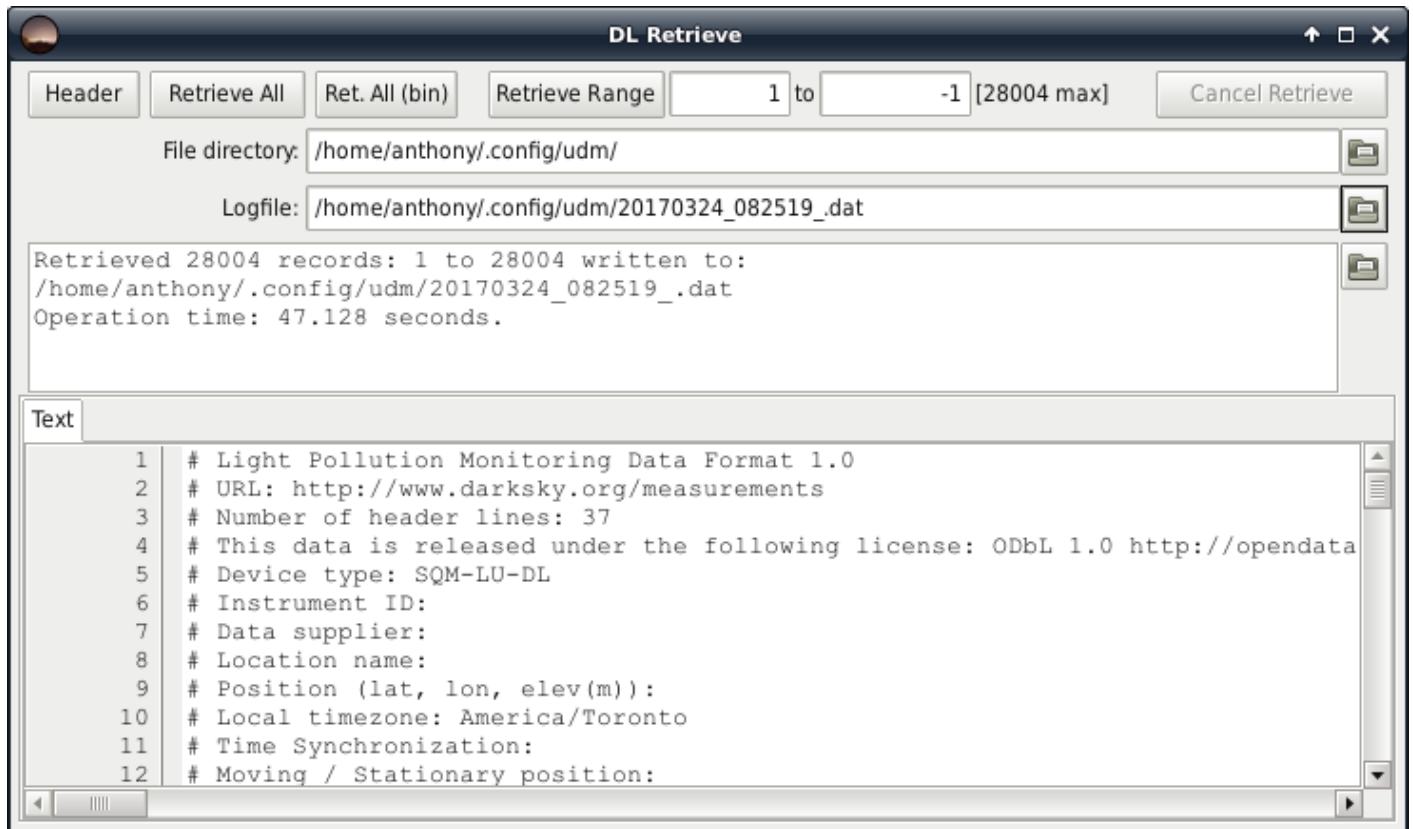

Figure 7.50: DL Retrieve dialog window

The retrieved fields of data are described in the header data.

Header The “Header” button calls up the details that are stored on the computer when a data-logger data is retrieved and written to disk. See page 32 for more information.

The definitions of the header fields can be seen from the link in the header screen.

Some extra definitions of retrieved fields:

Table 7.6: Extra definitions of retrieved fields

Column	Example value	Description
Std lin.	45000	<p>Linear frequency reading in standard mode (snow LED off). Available on models with snow LED.</p> <p>Standard linear luminance value taken with the snow LED off. The value is representative of the brightness (larger number = brighter). The linear value is a compensated value of 150 times the period counts or 45000 times the frequency, with a switchover point at determined by the crossover selection mode on the report interval page.</p> <p>A reading of 0000045000 would indicate a sensor frequency of 1Hz, but the meter limits to 25kHz for later scaling of snow factor, so the maximum value would be 1125045000 (25kHz × 45000).</p> <p>A reading of 0000000000 would indicate total darkness, but the meter limits time readings to 85 seconds maximum, so the darkest value "should" be: 0000000529 (1/85s × 45000).</p>
Snow MSAS	19.66	<p>Darkness reading when snow LED is on. Available on models with snow LED. Snow reading in mpsas which was taken when the snow LED was on.</p>
Snow lin.	63000	<p>Linear frequency reading when snow LED is on. Available on models with snow LED. Snow linear luminance value. The linear value is computed similarly to the standard linear value described above.</p>

Retrieve All Press the “Retrieve All” button to collect all recorded data points from the SQM-LU-DL-V unit and store to a file. Depending on the number of data-points, this action may take a long time.

When the retrieval is complete, the file location will be shown in the “recent file” section. You can access that stored file by pressing the file-folder icon to the right of that filename, the file contents will be shown in the text box at the bottom of the “DL Retrieve” dialog window.

Ret. All (bin) Faster than “Retrieve all”. Press the “Ret. All (bin)” button to collect all recorded data points from the SQM-LU-DL-V unit and store to a file. This action is available in firmware feature version 47 and above.

When the retrieval is complete, the file location will be shown in the “recent file” section. You can access that stored file by pressing the file-folder icon to the right of that filename, the file contents will be shown in the text box at the bottom of the “DL Retrieve” dialog window.

Retrieve Range Press the “Retrieve Range” button to collect recorded data points in a range defined by the next two fields (start-range to end-range) from the SQM-LU-DL-V unit and store to a file. Depending on the number of data-points, this action may take a long time.

The first record in the unit starts at 1.

The ending record is defined in the [xxx max] text displayed to the right of the end range. You can enter -1 into the end-range field to indicate the last record. An ending range beyond the max will pull in data records that have not yet been written to (odd values will be displayed).

When the retrieval is complete, the file location will be shown in the “recent file” section. You can access that stored file by pressing the file-folder icon to the right of that filename, the file contents will be shown in the text box at the bottom of the “DL Retrieve” dialog window.

Cancel Retrieve Press the “Cancel Retrieve” button to cancel a “Retrieve All” or ”Retrieve range” action.

Log one Press the “Log one” button to record a single record in the data log memory of the SQM-LU-DL-V. The data log window will be instantly updated with the result of your action and point to the latest record.

Erase All The “Erase All” button calls up the “Erase” dialog window shown below

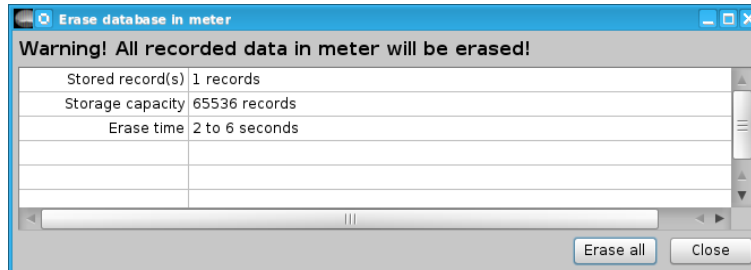

Figure 7.51: DL Erase dialog window

- The total size of erasable memory and range of erase time is shown.
- Pressing “Close” before the erasing starts will close this dialog window.
- Pressing the “Erase all” button on this dialog window starts the unstoppable erase procedure. All data log records will be removed from the SQM-LU-DL-V data log memory.
- While the erasing is taking place, the dialog window shows the current status of time taken to complete the erasure.

7.10 Vector datalogger

The SQM-LU-DL-V can be setup for an all-sky survey of brightness data points. Refer to Figure ?? for key points.

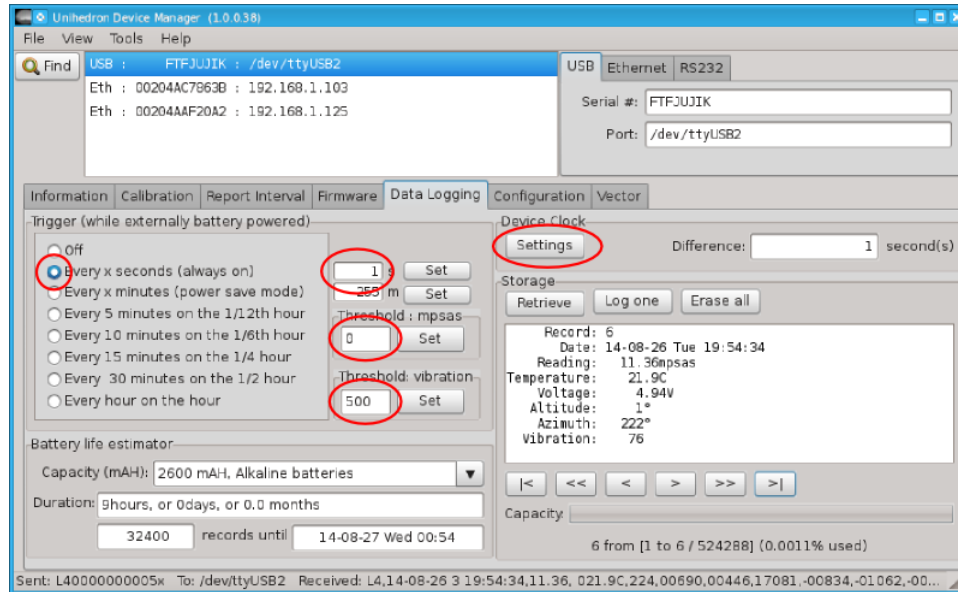

Figure 7.52: Datalogging page for vector model

7.10.1 Contour plot

Follow these steps to see a contour plot of the retrieved data:

- Select the “Tools - DL Retrieve” menu item or the “Data Logging” tab then the “Retrieve All” button.
- Select the “Plot” tab.
- Click the “Show data” button, and select the previously retrieved log file.
- The contour plot will appear after all the points have been read in and processed which could take a long time depending on the number of recorded points.

An example of the contour plot is shown in Figure ??.

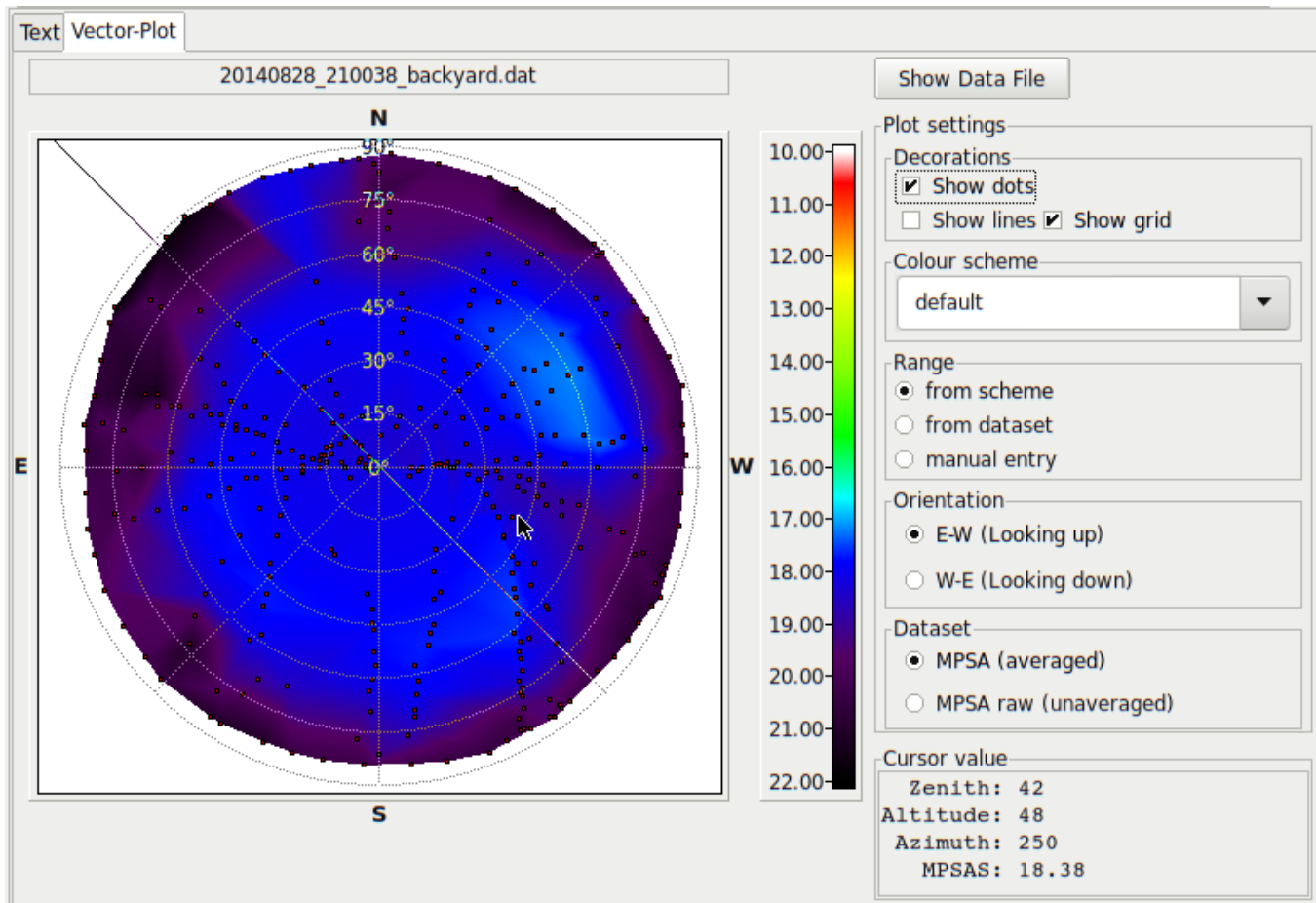

Figure 7.53: Contour plot of 336 readings

7.10.2 Minimum .dat requirements

The Contour plot reads records from a .dat file created by retrieving data from the SQM-LU-DL-V. You can use other methods to generate the Altitude and Azimuth field and make up a .dat file yourself. The minimum requirements for the .dat file to be read by the contour plotting function are:

- One comment line describing the field of UTC Date & Time, Altitude, Azimuth.
- One line defining the ending of the header.
- Following lines of data

Here is an example:

```
# UTC Date & Time, MSAS, Altitude, Azimuth
# END OF HEADER
2018-05-15T06:05:24.057;21.85;0;0
2018-05-15T06:05:34.040;21.86;20;0
```

7.11 Configuration tab

The “Configuration tab” shows the factory-set calibration values.

Calibration is performed at the Unihedron factory. A new calibration using a calibrated light source and darkroom can be performed by following the instructions on the right side of the screen. The calibration report can be logged to a data file and also printed out from this screen.

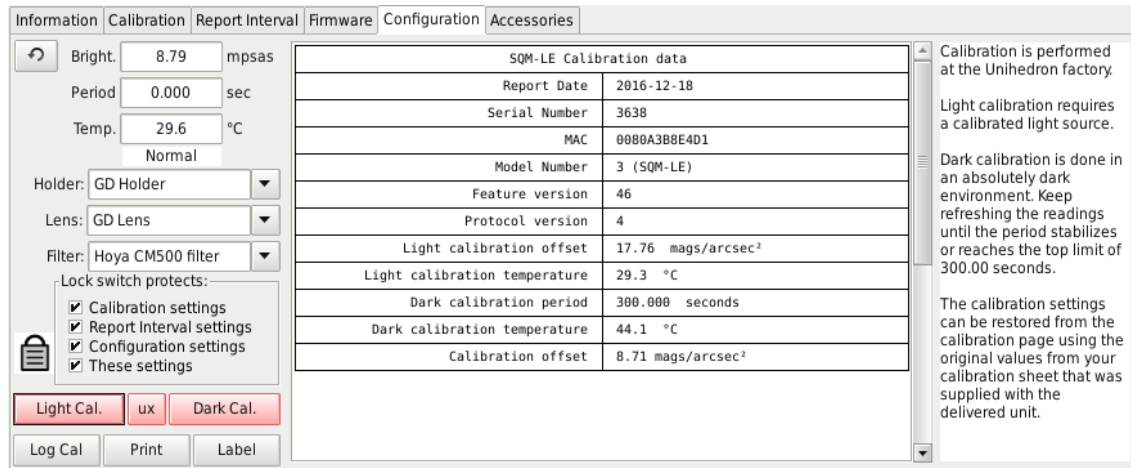

Figure 7.54: Configuration tab

Warning confirmations as shown in Figure 7.53 and Figure 7.54 are shown when trying to calibrate the unit yourself:

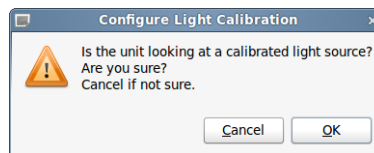

Figure 7.55: Light calibration confirmation

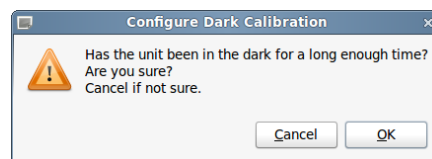

Figure 7.56: Dark calibration confirmation

7.11.1 Sensor arrangement

For documentation purposes, the SQM-LU-DL-V can store information on the sensor arrangement (starting at firmware feature 35 and above). The type of Lensholder, Lens, and Filter can be defined.

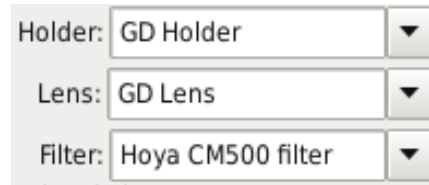

Figure 7.57: Sensor arrangement

7.12 Simulation tab

The “Simulation” tab is enabled from the View menu.

The “Simulation” tab allows the simulation of raw light sensor values for experimentation purposes. The “Start” button initiates feeding the range of values to the internal formulas of the SQM-LU-DL-V and results are displayed on this tab. Raw temperature conversions are detail in Eq: 8.1 and 8.2. The simulation will stop once all the steps are complete or when the “Stop” button is pressed.

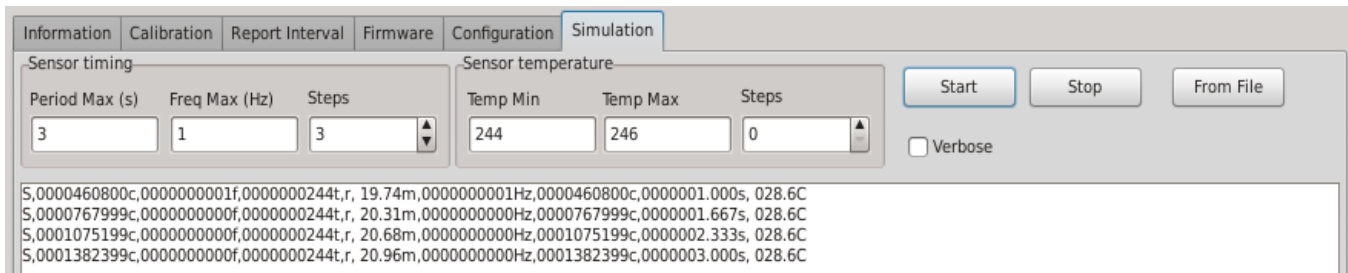

Figure 7.58: Fig:Simulation tab

When using the Simulation mode of the SQM-LU-DL-V, make sure that nothing else interrupts the sequence of readings such as external programs reading from the SQM-LU-DL-V, or settings of Interval reporting inside the SQM-LU-DL-V.

7.12.1 Simulation from file

The “From file” button sends csv data from `simin.csv` (in the log file directory) to the SQM-LU-DL-V in simulation mode and puts the output into `simout.csv`. The format of the csv is shown in Table 7.7:

Table 7.7: simin.csv field description

Position	Example value	Description
1	3000	Period in counts.
2	30	Frequency in Hz.
3	20.3	Temperature in °C.

Listing 7.2: simin.csv example

```
0,568380,24.8
72970,6,13.2
```

The resultant output records will be shown on the screen and saved in `simout.csv` (in the log file directory) in the form of simulated result shown in section 8.9 as in the example shown in Listing 7.3:

Listing 7.3: simout.csv example

```
# Simulation from file.
# UDM version: 1.0.0.43
# Unit information cx: i,00000004,00000003,00000032,00000704
# Calibration cx: c,00000019.80m,0000107.511s, 028.3C,00000008.71m, 029.3C
S,0000000000c,0000568380f,0000000232t,r, 00.00m,0000568380Hz,0000000000c,0000000.000s, 024.8C
S,0000072970c,00000000006f,0000000196t,r, 17.79m,00000000006Hz,0000072970c,0000000.158s, 013.2C
```

7.12.2 Test response

The button activates code to reset the SQM-LU-DL-V then send multiple **r1x** commands. Watch the log for **,F** to see when the SQM-LU-DL-V starts reporting fresh readings.

7.13 Accessory options

Some meters can be equipped/retro-fitted with optional accessories if they include firmware feature version ≥ 40 .

See section 8.6 for details on the accessory commands.

The accessories tab (shown in 7.57) is available when selecting a device that has the appropriate firmware:

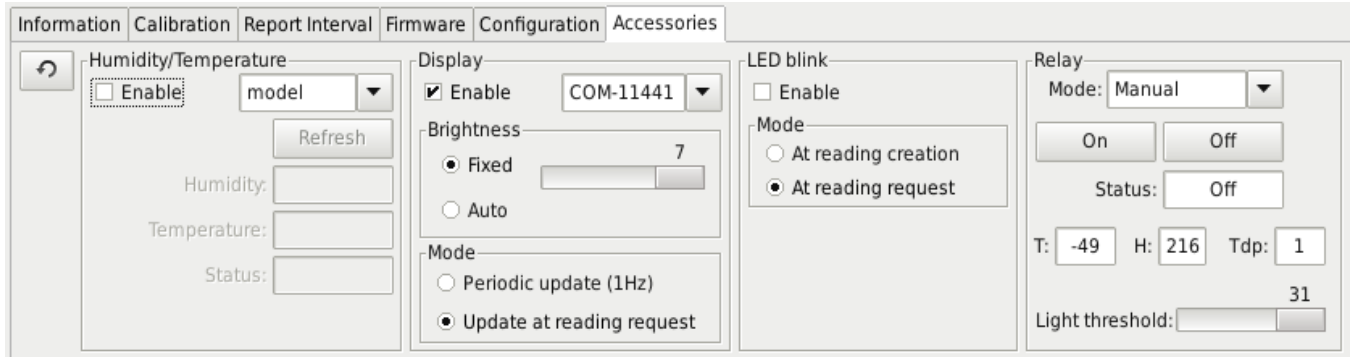

Figure 7.59: Accessories tab

7.13.1 Humidity accessory

The humidity sensor accessory option is currently not available for the SQM-LU-DL-V.

7.13.2 Display accessory

The display accessory option is currently not available for the SQM-LU-DL-V.

7.13.3 LED accessory

The SQM-LU-DL-V has the LED accessory hardware built in to the back panel.

The LED indicator accessory is mainly used for troubleshooting to identify either when readings are created or requested. The LED draws current and it may not be desirable to enable it when operating from the battery pack. The LED blinks for 1/60th of a second.

The LED can blink either when the SQM-LU-DL-V creates a reading, or when a reading is requested (using the rx command).

7.13.4 Relay accessory

The Relay accessory is mainly used for dew heater control. A 3.3V activated solid state relay can be connected directly to pin 23 of the micro-controller (25mA drive maximum).

When in Manual mode, the relay can be turned on or off.

When in Automatic mode, the relay is turned on when the mpsas reading is above the threshold and off when the mpsas reading is below the threshold.

Pressing the On/Off buttons while the relay is in automatic mode will switch it to manual mode.

7.14 Command line parameters

UDM can be started from the command line. Other stored parameters (like timezone) will be recalled automatically. Here is the summary of options:

Table 7.8: Log continuous command line parameters

Parameter	Description
-LCMS,x	Every x seconds
-LCMM,x	Every x minutes
-LCM,1	Every 1 minute on the minute
-LCM,5	Every 5 minutes on the 1/12th hour
-LCM,10	Every 10 minutes on the 1/6th hour
-LCM,15	Every 15 minutes on the 1/4 hour
-LCM,30	Every 30 minutes on the 1/2 hour
-LCM,60	Every hour on the hour
-LCR	Start recording right away
-LCMIN	Minimize Application after Log continuous window starts up
-LCTH,x	Threshold setting. Readings equal to or greater than x (in mpsas) get recorded. If x=0 then all readings are get recorded.
-LCGRS	Run GoTo script then shut down when done

Table 7.9: Select device command line parameters

Parameter	Description
-SEI,x	Select Ethernet device where x = IP address
-SEM,x	Select Ethernet device where x = MAC address
-SUC,x	Select USB device where x = communication port-name i.e. /tty/USB0
-SUI,x[,y...]	Select USB device where x = ID number ex FTD12345, or multiple IDs for LogContinuous with the first one being the priority set like: -SUI,FTD12345,FTD33333,FTD55555

Table 7.10: Select features command line parameters

Parameter	Description
-N	Do not search for devices at startup. This cuts down startup time, the user must press the Find button to find devices.
-P	Display plotter window.
-TCA	Start up Concatenate/Analyze tool
-TCM	Start up Cloud removal / Milky way position tool

Table continued on next page ...

Table 7.10 – *continued from previous page*

Parameter	Description
-TCMR	Start up Cloud removal / Milky way position tool, and recall previous filename

7.14.1 Internal startup options

UDM also has the ability to store the startup options internally so that no extra command line parameters are required. You can access this setting from **File -> Startup options** menu.

7.14.2 Windows autostartup

To get Windows to open up UDM at startup:

- Select the Start button and scroll to find the Unihedron Device Manager app that you want to run at startup.
- Right-click the app, select More, and then select Open file location. This opens the location where the shortcut to the app is saved. If there isn't an option for Open file location, it means the app can't run at startup.
- With the file location open, press the Windows logo key + R, type shell:startup, then select OK. This opens the Startup folder.
- Copy and paste the shortcut to the app from the file location to the Startup folder.

To get UDM to start the log continuous feature when starting up:

- Make sure that you already tested the Log Continuous feature so that it works correctly.
- Press the Windows logo key + R, type shell:startup, then select OK.
- Right click on the UDM icon that should have been there from the above steps
- Show more options, then press Properties
- Edit the TARGET to put double quote marks around the executable, but do not change the text, and add a space and then **-LCR** to end. It will look something like this:
`"C:\Users\User\AppData\Local\Unihedron\udm.exe" -LCR`

Note: If you have more than one device that UDM finds, then it will be important to identify that device on startup, for example like this example to find the USB device with USB ID 12345678 and starts logging to disk:

```
"C:\Users\User\AppData\Local\Unihedron\udm.exe" -SUI,12345678 -LCR
```

Note: You can leave out the above optional parameters from the command line if you include those in the internal startup options in the UDM **File -> Startup options** menu.

7.14.3 Windows scheduled startup

In Windows, you can use the **Task Scheduler** to start and stop recording.

First make sure that UDM can read your meter and can log data using the Log Continuous feature. Also, use UDM to determine the MAC address of the meter (on the main page). Then, close UDM.

Enter the start/stop times into the Windows Task Scheduler. Start the task scheduler as follows:

1. Click the Windows "Start" button
2. Start typing Schedule Tasks
3. Select the Schedule Tasks or Task Scheduler program.

Then:

1. Press "Create basic task" on the right side in the Actions window.
2. Name: Start UDM
3. Next
4. Daily
5. Enter the desired start time
6. Select Start a program
7. Click on browse to find the program which is usually located at "C:\Users\User\AppData\Local\Programs\Unihedron\udm.e
8. For SQM-LE, Enter additional parameter: **-SEM,x -LCM,y -LCR**
 where **x** is the MAC address of the SQM-LE to be monitored, for example: 00204AAF20A2
 where **y** is the number of minutes between recordings, for example: 5
 For SQM-LU, Enter additional parameter: **-SUC,x -LCM,y -LCR**
 where **x** is the MAC address of the SQM-LU to be monitored, for example: COM1
 where **y** is the number of minutes between recordings, for example: 5
 More command line definitions found in **UDM->Help->Command line information**
9. Next, Finish

Tasks may not show up in the Task Scheduler library immediately, you may have to close the Task scheduler and re start it.

Then, make another task to stop UDM at a specific time as follows:

1. Press "Create basic task" on the right side in the Actions window.
2. Name: Stop UDM
3. Next
4. Daily
5. Enter the desired stop time
6. Select Start a program
7. Type the following into the program area: taskkill
8. Enter additional parameters: /IM udm.exe /F
9. Next, Finish

The logged files are stored in your log directory, usually located at: "C:\ProgramData\Unihedron\logs"

The above was tested with Windows 10 and UDM ver.105.

7.14.4 Mac autostartup

You can have UDM start up when you login to your Mac. Enter your UDM startup parameters in the UDM File -> Startup options menu. Then add UDM to the Mac Login items as follows:

- Go to **System Preferences > Users & Groups** from the main Mac menu.
- Select your user account in the list on the left
- Click **Login Items**.
- Click the **Add** button.
- Select **UDM** from the **Applications** folder.

8 Commands and responses

The SQM-LU-DL-V accepts a sequence of characters as a command, then executes those commands and usually provides a response of a sequence of characters. The following details are useful when programming your own interface to send data to and receive data from the SQM-LU-DL-V.

8.1 Commands

Commands consist of a string of characters. The first character is the command type. The following is a list of the “Standard” commands:

Table 8.1: Summary of standard commands

Command	Description
rx r1x Rx R1x	Reading request (averaged).
ux u1x Ux U1x	Unaveraged reading requests.
rfx rFx	Linear, Inline linear reading requests.
r2x	Reading request including DL supply voltage.
cx	Calibration information request.
ix	Unit information request (note lower case “i”).
zcalAx	Arm Light Calibration command.
zcalBx	Arm Dark Calibration command.
zcalDx	Disarm Calibration command. Also reports the lock switch status.
zcal5	Manually Set Light Calibration Offset.
zcal6	Manually Set Light Calibration Temperature.
zcal7	Manually Set Dark Calibration Time Period.
zcal8	Manually Set Dark Calibration Temperature.
0x19	Reset micro-controller. Hexadecimal value 19. See the “Firmware Upgrade” chapter on page 113 for more details.
:	Intel Hex firmware upgrade initiation. See the “Firmware Upgrade” chapter on page 113 for more details.
P...x	Set period (in seconds) for interval reporting to EEPROM and RAM for booting and immediate use. Firmware feature=13.
p...x	Set period (in seconds) for interval reporting to RAM for immediate use. Firmware feature=13.
T...x	Set threshold (in $\frac{mag}{arcsec^2}$) for interval reporting only to EEPROM and RAM for booting and immediate use. Firmware feature \geq 13.
t...x	Set threshold (in $\frac{mag}{arcsec^2}$) for interval reporting only to RAM for immediate use. Firmware feature \geq 13.
Ix	Request interval settings (note upper case “I”). Firmware feature \geq 13.
sx	Request reading of internal variables.
S...x	Simulate internal calculations.

The following is a list of the “Data logger” commands:

The following is a list of the “Vector” model commands:

Table 8.2: Summary of datalogger commands

Command	Description
L0x	Report on FLASH chip Manufacturer ID, and Device ID.
L1x	Report on logging pointer.
LZx	Report on logging capacity.
L2x	Erase entire FLASH chip contents.
L3x	Log one record.
L4...x	Return one record.
L5x	Get battery voltage.
L6x	Get status register1.
L7x	Report on bytes per FLASH, bytes per record.
LM.x	Set Logging trigger mode, next digit defines mode.
Lmx	Get Logging trigger mode.
LIX	Logging Interval settings requested.
LPS...x	Logging Interval period set in seconds.
LPM...x	Logging Interval period set in minutes.
LT...x	Logging Threshold for interval reports set.
Lcx	Get real time clock data.
LC...x	Set real time clock data.
Lsx	Put unit to sleep.
Lax	Get alarm data.

Table 8.3: Summary of vector commands

Command	Description
v1x	Magnetic readings.
v2x	Acceleration readings.
v3...x	Save/Get Acceleration calibration (v3x or v3,-12345, ...x or v3, 12345, ... x).
v4...x	Save/Get Magnetic calibration.
vvx	Vibration report.
vtx	Get Vibration threshold.
vTx	Set Vibration threshold.

8.2 Response details

8.2.1 Reading request

The “Reading” request “**rx**” or “**Rx**” commands the SQM-LU-DL-V to provide the current darkness value as well as all variables used to generate that result.

Readings produced by this request are averaged internally by using the last 8 readings and shifting those values through an 8 cell buffer then summing and dividing by 8. Use the “**ux**” command to get the un-averaged and most recent value. Averaging is only performed on period-mode readings (when the light sensor frequency is below 128Hz). Frequency mode

readings (above 128Hz) are automatically averaged because the reading is taken from a one second sampling of pulses. The format of the rx response is shown in table 8.3:

Table 8.4: rx Reading request response

Column	Example value	Description
0	r	Indicates that a reading is being returned.
2-8	_06.70m	Reading in $\frac{mag}{arcsec^2}$. Leading space for positive value. Leading negative sign (-) for negative value. A reading of 0.00m means that the light at the sensor has reached the upper brightness limit of the unit.
10-21	0000022921Hz	Frequency of sensor in Hz.
23-33	0000000020c	Period of sensor in counts. Counts occur at a rate of 460.8 kHz (14.7456MHz/32).
35-46	0000000.000s	Period of sensor in seconds with millisecond resolution. Determined by dividing the above counts value by 460800.
48-54	_039.4C	Temperature measured at light sensor in degrees C. The value is averaged and presented every 4.3 seconds. Leading space for positive value. Leading negative sign (-) for negative value.
55-56	$\begin{matrix} C \\ L \\ R \\ F \end{matrix}$	Carriage return (0x0d), Line feed (0x0a).

An example of the response is:

```
r, 06.70m,0000022921Hz,0000000020c,0000000.000s, 039.4C $\begin{matrix} C \\ L \\ R \\ F \end{matrix}$ 
0123456789 123456789 123456789 123456789 123456789 123456
```

Future versions of this reading string will only modify reported values beyond position 54. Characters 0 to 54 may be considered stable.

A special case “Rx” command returns the serial number in the same format as the interval report does. See page 106 “Setting Interval reporting parameters” for report details.

To include the “Freshness” status, use the “r1x” command. The response is shown in table 8.4

Table 8.5: r1x Reading request response

Column	Example value	Description
0	r	Indicates that a reading is being returned.
2-8	_06.70m	Averaged reading in $\frac{mag}{arcsec^2}$. Leading space for positive value. Leading negative sign (-) for negative value. A reading of 0.00m means that the light at the sensor has reached the upper brightness limit of the unit.
10-21	0000022921Hz	Frequency of sensor in Hz.
23-33	0000000020c	Period of sensor in counts. Counts occur at a rate of 460.8 kHz (14.7456MHz/32).
35-46	0000000.000s	Period of sensor in seconds with millisecond resolution. Determined by dividing the above counts value by 460800.

Table continued on next page ...

Table 8.5 – *continued from previous page*

Column	Example value	Description
48-54	_039.4C	Temperature measured at light sensor in degrees C. The value is averaged and presented every 4.3 seconds. Leading space for positive value. Leading negative sign (-) for negative value.
56-72	_06.53m	Unaveraged reading in $\frac{mag}{arcsec^2}$. Leading space for positive value. Leading negative sign (-) for negative value. A reading of 0.00m means that the light at the sensor has reached the upper brightness limit of the unit.
74	F	Freshness state, either: F: fresh FREQUENCY mode reading. P: fresh PERIOD mode reading. S: STALE reading indicates that this reading has not changed since the last reading because there was not enough light gathered to produce a new reading.
75-76	$\begin{smallmatrix} \text{C} \\ \text{R} \\ \text{F} \end{smallmatrix}$	Carriage return (0x0d), Line feed (0x0a).

An example of the response is:

```
r, 06.70m,0000022921Hz,0000000020c,0000000.000s, 039.4C, 06.53m,F $\begin{smallmatrix} \text{C} \\ \text{R} \\ \text{F} \end{smallmatrix}$ 
0123456789 123456789 123456789 123456789 123456789 123456789 123456
```

The **r1x** request response is the same as **rx**, with the freshness status of Frequency/Period/Stale (**,F ,P ,S**) appended

The **Rx** request response is the same as **rx**, with the serial number appended.

The **R1x** request response is the same as **rx**, with freshness status of Frequency/Period/Stale (**,F ,P ,S**), and the serial number appended.

8.2.2 Unaveraged reading request

The “unaveraged reading” request **ux** commands the meter to provide the current darkness value as well as all variables used to generate that result. This readings is not averaged out like the **rx** command.

The format of the **ux** response is shown in table 8.5:

Table 8.6: Unaveraged reading request response

Column	Example value	Description
0	u	Indicates that a reading is being returned.
2-8	_06.70m	Averaged Reading in $\frac{mag}{arcsec^2}$. Leading space for positive value. Leading negative sign (-) for negative value. A reading of 0.00m means that the light at the sensor has reached the upper brightness limit of the unit.
10-21	0000022921Hz	Frequency of sensor in Hz.
23-33	0000000020c	Unaveraged Period of sensor in counts. Counts occur at a rate of 460.8 kHz (14.7456MHz/32).

Table continued on next page ...

Table 8.6 – continued from previous page

Column	Example value	Description
35-46	0000000.000s	Unaveraged period of sensor in seconds with millisecond resolution. Determined by dividing the above counts value by 460800.
48-54	_039.4C	Unaveraged temperature measured at light sensor in degrees C. The value is presented every 4.3 seconds. Leading space for positive value. Leading negative sign (-) for negative value.
55-56	C L R F	Carriage return (0x0d), Line feed (0x0a).

An example of the response is:

**u, 06.70m,0000022921Hz,0000000020c,0000000.000s, 039.4C C L
 R F**
0123456789 123456789 123456789 123456789 123456789 123456

The **u1x** request response is the same as **ux**, with the unaveraged reading, and the freshness status of Frequency/Period/Stale (**,F ,P ,S**) appended.

The **Ux** request response is the same as **ux**, validity/invalidity (**,V ,I**) appended.

The **U1x** request response is the same as **ux**, with the unaveraged reading, and the freshness status of Frequency/Period/Stale (**,F ,P ,S**) appended.

8.2.3 Linear reading request

The “linear reading” request “**rfx**” commands the meter to provide the current brightness value proportional to the light flux or frequency output from the light sensor. This value is compensated for only by the dark current frequency.

$$f_{out} = f_{light} - f_{dark}$$

To allow for long period measurements, the output integer value is scaled up by a factor of 45,000.

$$n_{out} = f_{out} \times 45000$$

The format of the response is shown in table 8.6:

Table 8.7: Linear reading request response

Column	Example value	Description
0-1	f,	Indicates that a frequency reading is being returned.
2-11	0001287103	Frequency reading. A reading of 0000045000 would indicate a sensor frequency of 1Hz, but the meter limits to 25kHz for later scaling of snow factor, so the maximum value would be 1125045000 ($25kHz \times 45000$). A reading of 0000000000 would indicate total darkness, but the meter limits time readings to 85 seconds maximum, so the darkest value would be 0000000529 ($\frac{1}{85s} \times 45000$).
12-13	C L R F	Carriage return (0x0d), Line feed (0x0a).

An example of the response is:

**f,0001287103 C L
 R F**
0123456789 123

8.2.4 Inline linear reading request

The “inline linear reading” request “**rFx**” (note: capital F) commands the meter to include the current brightness value proportional to the light flux or frequency output from the light sensor. This value is compensated for only by the dark current frequency.

$$f_{out} = f_{light} - f_{dark}$$

To allow for long period measurements, the output integer value is scaled up by a factor of 45,000.

$$n_{out} = f_{out} \times 45000$$

The format of the response is similar to the “rx” response and is shown in table 8.7:

Table 8.8: Inline linear reading request response

Column	Example value	Description
0	r	Indicates that a reading is being returned.
2-8	_06.70m	Reading in $\frac{mag}{arcsec^2}$. Leading space for positive value. Leading negative sign (-) for negative value. A reading of 0.00m means that the light at the sensor has reached the upper brightness limit of the unit.
10-21	0000022921Hz	Frequency of sensor in Hz.
23-33	0000000020c	Period of sensor in counts. Counts occur at a rate of 460.8 kHz (14.7456MHz/32).
35-46	0000000.000s	Period of sensor in seconds with millisecond resolution. Determined by dividing the above counts value by 460800.
48-54	_039.4C	Temperature measured at light sensor in degrees C. The value is averaged and presented every 4.3 seconds. Leading space for positive value. Leading negative sign (-) for negative value.
56-65	0001287103	Frequency reading. A reading of 0000045000 would indicate a sensor frequency of 1Hz, but the meter limits to 25kHz for later scaling of snow factor, so the maximum value would be 1125045000 ($25kHz \times 45000$). A reading of 0000000000 would indicate total darkness, but the meter limits time readings to 85 seconds maximum, so the darkest value would be 0000000529 ($\frac{1}{85s} \times 45000$).
66-67	␣␣	Carriage return (0x0d), Line feed (0x0a).

An example of the response is:

r, 06.70m,0000022921Hz,0000000020c,0000000.000s, 039.4C,0001287103␣␣
0123456789 123456789 123456789 123456789 123456789 123456789 1234567

8.2.5 Unit information

Unit information command “ix” provides details about the software in the micro-controller.

The format of the response is:

Table 8.9: Unit information request response

Column	Example value	Description
0	i	Indicates that the unit information response is being returned.
2-9	00000002	Protocol number (8 digits). This will always be the first 8 characters (after the “i,” response). This value indicates the revision number of the data protocol to/from the SQM-LU-DL-V. The protocol version is independent of the feature version.
11-18	00000003	Model number (8 digits). The model value identifies the specific hardware model that the firmware is tailored for.
20-27	00000001	Feature number (8 digits). The feature value identifies software features. This number is independent of the data protocol.
29-36	00000413	Serial number (8 digits). Each unit has its own unique serial number.
37-38	␣␣	Carriage return (0x0d), Line feed (0x0a).

An example of the response is:

```
i,00000002,00000003,00000001,00000413␣␣
0123456789 123456789 123456789 12345678
```

8.3 Calibration commands

8.3.1 Calibration information request

The calibration information request “cx” returns all data about the specific light sensor in the unit required to calculate a reading.

The format of the response is shown in table 8.9:

Table 8.10: Calibration information request response

Column	Example value	Description
0	c	Indicates that the calibration information is being returned.
2-13	00000017.60m	Light calibration offset in $\frac{mag}{arcsec^2}$.
15-26	0000000.000s	Dark calibration time period in seconds with millisecond resolution.
28-34	_039.4C	Temperature in degrees C measured during light calibration. Leading space for positive value. Leading negative sign (-) for negative value.
36-47	00000008.71m	Offset of light sensor in $\frac{mag}{arcsec^2}$ based on manufacturing reference. The factory calibration light source is equivalent to $8.71 \frac{mag}{arcsec^2}$, and when the “Light calibration” button is pressed in UDM, the meter creates the light calibration offset value (17.60 in this case) so that the meter reads 8.71 also.
49-55	_039.4C	Temperature in degrees C measured during dark calibration. Leading space for positive value. Leading negative sign (-) for negative value.
56-57	␣␣	Carriage return (0x0d), Line feed (0x0a).

An example of the response is:

```
c,00000017.60m,0000000.000s, 039.4C,00000008.71m, 039.4CRLF
0123456789 123456789 123456789 123456789 123456789 1234567
```

8.3.2 Light calibration command

Calibration of the SQM-LU-DL-V is done at the factory in a controlled light and temperature environment.

Executing the Light calibration command “zcalAx” arms the light calibration mode.

A calibrated light source of approximately 13.5fc is supplied to the sensor.

The format of the response is shown in table 8.10:

Table 8.11: Light calibration response

Column	Example value	Description
0	z	Indicates that a “Calibration” response is being returned.
1	A	Indicates Light Calibration mode.
2	a	Indicates that the calibration is armed.
3	L	L = Locked; Wait for unlock before calibrating after Arm command, firmware upgrades are disabled. U = Unlocked; Calibrate immediately after Arm command, Enable firmware upgrade.
4-5	C_R^L_F	Carriage return (0x0d), Line feed (0x0a).

An example of the response is:

```
zAaLRLF
012345
```

8.3.3 Dark calibration command

Dark Calibration is done at the factory along with Light calibration and calibration temperature recording.

Executing the dark calibration command “zcalBx” arms the dark calibration mode.

Dark calibration is performed in a completely dark environment. Check a reading to ensure that the period is correct after entering the dark environment, it could take a few minutes to collect an accurate dark period. A dark period of only a few seconds is too small.

The format of the response is shown in table 8.11:

Table 8.12: Dark calibration response

Column	Example value	Description
0	z	Calibration response is being returned.
1	B	Dark Calibration.
2	a	Armed.
3	L	L = Locked; Wait for unlock before calibrating after Arm command, firmware upgrades are disabled. U = Unlocked; Calibrate immediately after Arm command, Enable firmware upgrade.

4-5	$\begin{matrix} \text{C} \\ \text{L} \\ \text{R} \\ \text{F} \end{matrix}$	Carriage return (0x0d), Line feed (0x0a).
-----	--	---

An example of the response is:

```
zBaL $\begin{matrix} \text{C} \\ \text{L} \\ \text{R} \\ \text{F} \end{matrix}$ 
012345
```

8.3.4 Disarm calibration command

The Disarm calibration command “zcalDx” disarms calibration modes from being triggered by the unlock mode.

The format of the response is shown in table 8.12:

Table 8.13: Disarm calibration response

Column	Example value	Description
0	z	Calibration response is being returned.
1	x	Indicates “All” calibration modes.
2	d	Disarmed.
3	L	L = Locked; Wait for unlock before calibrating after Arm command, firmware upgrades are disabled. U = Unlocked; Calibrate immediately after Arm command, Enable firmware upgrade.
4-5	$\begin{matrix} \text{C} \\ \text{L} \\ \text{R} \\ \text{F} \end{matrix}$	Carriage return (0x0d), Line feed (0x0a).

An example of the response is:

```
zxdL $\begin{matrix} \text{C} \\ \text{L} \\ \text{R} \\ \text{F} \end{matrix}$ 
012345
```

8.3.5 Manually set light calibration offset

Calibration is done at the factory, however, in the case where calibration values must be restored or set to something else, this command allows a new calibration value to be placed into the meter.

Executing the command “zcal5#####.##x” manually sets the light calibration offset to the value specified in “#####.##”. The units are $\frac{\text{magnitudes}}{\text{arcsecond}^2}$.

The format of the response is shown in table: 8.13:

Table 8.14: Response for manual setting of light calibration offset

Column	Example value	Description
0	z	Calibration response is being returned.
2	5	Manual Set Light Calibration Offset
4-15	00000017.60m	Value that was set into EEPROM
16-17	$\begin{matrix} \text{C} \\ \text{L} \\ \text{R} \\ \text{F} \end{matrix}$	Carriage return (0x0d), Line feed (0x0a).

An example of the response is:

```
z,5,00000017.60m $\begin{matrix} \text{C} \\ \text{L} \\ \text{R} \\ \text{F} \end{matrix}$ 
0123456789 1234567
```

8.3.6 Manually set light calibration temperature

Calibration is done at the factory, however, in the case where calibration values must be restored or set to something else, this command allows a new calibration value to be placed into the meter.

The “Light calibration temperature” is the temperature of the meter when the meter was calibrated for its “Light calibration offset”.

Executing the command “zcal6#####.##x” manually sets the light calibration temperature to the value specified in “#####.##”. The units are °C.

Note: The meter records the temperature in a raw value with different resolution, so the reply back may not be exactly the same as the value sent.

The format of the response is shown in table: 8.14:

Table 8.15: Response for manually setting of light calibration temperature

Column	Example value	Description
0	z	Calibration response is being returned.
2	6	Manual Set Light Calibration Offset
4-9	019.0C	Value that was set into EEPROM
10-11	␣␣	Carriage return (0x0d), Line feed (0x0a).

An example of the response is:

```
z,6,019.0C␣␣
0123456789 1
```

8.3.7 Manually set dark calibration time period

Calibration is done at the factory, however, in the case where calibration values must be restored or set to something else, this command allows a new calibration value to be placed into the meter.

The “Dark calibration time period” is the amount of time that has elapsed for the light sensor to make one cycle while in complete darkness. The meter sets a time limit of 300 seconds on this value.

Executing the command “zcal7#####.##x” manually sets the light calibration offset to the value specified in “#####.##”. The units are in seconds.

The format of the response is shown in table: 8.15:

Table 8.16: Response of manually setting dark calibration time period

Column	Example value	Description
0	z	Calibration response is being returned.
2	7	Manual Set Dark Calibration time period.
4-15	0000300.000s	Value that was set into EEPROM
16-17	␣␣	Carriage return (0x0d), Line feed (0x0a).

An example of the response is:

```
z,7,0000300.00s␣␣
0123456789 1234567
```

8.3.8 Manually set dark calibration temperature

Calibration is done at the factory, however, in the case where calibration values must be restored or set to something else, this command allows a new calibration value to be placed into the meter.

The “Dark calibration temperature” is the temperature of the meter when the meter was calibrated for its “Dark calibration time period”.

Executing the command “zcal8#####.##x” manually sets the light calibration offset to the value specified in “#####.##”. The units are °C.

Note: The meter records the temperature in a raw value with different resolution, so the reply back may not be exactly the same as the value sent.

The format of the response is shown in table: 8.16:

Table 8.17: Response for manually setting of dark calibration temperature

Column	Example value	Description
0	z	Calibration response is being returned.
2	8	Manual Set Dark Calibration temperature.
4-9	019.0C	Value that was set into EEPROM
10-11	$\overset{C}{R} \overset{L}{F}$	Carriage return (0x0d), Line feed (0x0a).

An example of the response is:

```
z,8,019.0C $\overset{C}{R}$  $\overset{L}{F}$ 
0123456789 1
```

8.4 Snow LED accessory

An LED used for determining snow cover on the meter can be attached to an internal pin of the SQM-LU-DL-V . This LED shines green light out of the meter and the light sensor will see a reflection if snow is covering the meter (housing cap). The light meter reading will be unchanged with no snow present, and about $1.6 \frac{mag}{arcsec^2}$ brighter with snow cover present.

Table 8.18: Snow LED accessory command summary

Command	Description
A50x	Turn off the Snow LED accessory.
A51x	Turn on the Snow LED accessory.
A5ex	Enable Snow LED logging (while on battery power).
A5dx	Disable Snow LED logging (while on battery power).
A5x	LED accessory status.

Table 8.19: Snow LED accessory response summary

Position	Example value	Description
0-2	A5,	Confirmation Snow LED accessory command.
3	n	Where $n = 0$ indicates the Snow LED is Off. 1 indicates the Snow LED is On.
4	m	Where $m = 0$ indicates the Snow LED is disabled. 1 indicates the Snow LED is enabled.

Table continued on next page ...

Table 8.19 – *continued from previous page*

Column	Example value	Description
5-6	$\overset{\text{C}}{\underset{\text{R}}{\text{L}}}\overset{\text{L}}{\underset{\text{F}}{\text{F}}}$	Carriage return (0x0d), Line feed (0x0a).

An example response to “A5x” is:

A5,01 $\overset{\text{C}}{\underset{\text{R}}{\text{L}}}\overset{\text{L}}{\underset{\text{F}}{\text{F}}}$
0123456

8.5 Datalogger commands

The SQM-LU-DL-V contains datalogging capabilities.

All of the datalogging commands begin with “L”.

8.5.1 FLASH ID report

The FLASH memory chip stores all the data logging records. It does not contain any calibration information.

The ID report is useful for determining the exact model of FLASH device inside the SQM-LU-DL-V for record capacity calculations.

To get a report on FLASH chip Manufacturer ID, and Device ID, use “L0x”. The response is shown in table 8.19:

Table 8.20: Response of requesting the FLASH chip ID

Column	Example value	Description
0-2	L0,	Confirmation of command.
3-5	000	Manufacturer ID.
6-8	000	Device ID.
9-10		Carriage return (0x0d), Line feed (0x0a).

An example response is:

```
L0,000,000
0123456789 1
```

8.5.2 Logging pointer report

To get a report on current logging pointer position, use the “L1x” command.

This pointer is the record address of where the next record will be stored.

Note: Before feature 27, the pointer position was only 6 characters long, from feature 27 onwards, the pointer position is 10 characters long. The response is shown in table 8.20:

Table 8.21: Response of requesting the data logging pointer

Column	Example value	Description
0-2	L1,	Confirmation of command
3-12	0000000000	Pointer position 0 means that no records have been stored. 1 means that one record has been stored. When the FLASH memory is full, this number will always point to the last record and will be equal to the storage capacity (see LZx). I.e. 1048575 for the larger memory
13-14		Carriage return (0x0d), Line feed (0x0a).

An example response is:

```
L1,0000000000
0123456789 1234
```

8.5.3 Logging capacity report

To get the total logging capacity of the FLASH memory chip installed in the meter, use the “LZx” command. This command is available on feature ≥ 27 . The response is shown in table 8.21:

Table 8.22: Response of requesting the data logging capacity

Column	Example value	Description
0-2	LZ,	Confirmation of command
3-8	0000032768	Capacity of records that can be stored in the FLASH memory. Ex. 32768, 65536, 524288, or 1048576.
9-10		Carriage return (0x0d), Line feed (0x0a).

An example response is:

```
LZ,0001048567
0123456789 1234
```

8.5.4 Erase entire FLASH memory

Erasing the entire FLASH memory deletes all previously recorded datalogged records. To erase the entire FLASH memory, use the “L2x” command. There is no response.

8.5.5 Log one record

To force the unit to record one complete record into the FLASH memory, use the “L3x” command.

The record will not be logged if the threshold is set too high. To ensure that a record will be logged, set the threshold to 0.

Note: Before feature 27, the pointer position was only 6 characters long, from feature 27 onwards, the pointer position is 10

The response includes the logging pointer as shown in table 8.22:

Table 8.23: Response of requesting to log one record

Column	Example value	Description
0-2	L3,	Confirmation of command
3-12	0000000000	Pointer position of next record
13-14		Carriage return (0x0d), Line feed (0x0a).

An example response is:

```
L3,0000000000
0123456789 1235
```

8.5.6 Return one logged record

To get one entire record, use the “L4...x” command. The request and response are as shown in table 8.23 and 8.24:

Table 8.24: Request to return one logged record

Column	Example value	Description
0-1	L4	Command.
2-11	0000000000	Pointer position of record to return. Value starts at 0 for record 1. Unwritten (erased) records will respond as follows: L4,55-55-55 5 55:55:55,00.00,-873.4C,255
12	x	End of request.
13-14		Carriage return (0x0d), Line feed (0x0a).

Table 8.25: Response to return one logged record

Column	Example value	Description
3char	L4,	Confirmation of command.
20char	11-01-06 5 11:51:00,	Date, Day of week (1=Sunday), and time of recording
7-8char	10.44,	Reading with sign. * Uncalibrated meter may respond with leading negative sign (ex. -11.49) which extends the length of the string.
8char	023.8C,	Temperature in degrees C. Leading space replaced with negative sign for negative temperature.
4char	234,	Battery voltage ADC value.
41-	-02790,	Ax. Acceleration in the X dimension. Signed five digit comma separated variable.
	-01013,	Ay. Acceleration in the Y dimension. Signed five digit comma separated variable.
	17051,	Az. Acceleration in the Z dimension. Signed five digit comma separated variable.
	01084,	Mx. Magnetometer value in the X dimension. Signed five digit comma separated variable.
	00301,	My. Magnetometer in the Y dimension. Signed five digit comma separated variable.
	-02748,	Mz. Magnetometer in the Z dimension. Signed five digit comma separated variable.
	00214,	Vibration value. Signed five digit comma separated variable.
1char	1	0 = First logged record from initial connection to battery. 1 = Subsequent logged reading triggered by time interval. Available on firmware feature 49 and above.
2char	,1	Available on models with snow LED. 0 = No snow data recorded. 1 = Snow data recorded. Available on firmware feature 66 and above.

Table continued on next page ...

Table 8.25 – *continued from previous page*

Column	Example value	Description
number	,1234567890	Available on models with snow LED. Standard linear luminance value taken with the snow LED off. The value is representative of the brightness (larger number = brighter). The linear value is a compensated value of 150 times the period counts or 45000 times the frequency, with a switchover point at determined by the crossover selection mode on the report interval page.
7-8char	,9.72	Available on models with snow LED. Snow reading in mpsas which was taken when the snow LED was on.
number	,1234567890	Available on models with snow LED. Snow linear luminance value. The linear value is computed similarly to the standard linear value described above.
last two		Carriage return (0x0d), Line feed (0x0a).

An example response is:

L4,11-01-06 5 11:51:00,10.44, 023.8C,234,-02790,-01013,17053,01084,00301,-02748,00214,1

8.5.7 Retrieve all Binary

To retrieve all records from the SQM-LU-DL-V faster than the “Return One logged record method”, you can use this faster binary method.

The first command sent “L8x” returns the packet length, and number of packets to be sent. The response to this first command is below:

Table 8.26: Response to Binary Retrieve command

Column	Example value	Description
0-2	L8,	Confirmation of command.
3-13	1234567890,	Packet length.
14-24	1234567890	Number of packets.
25,26		Carriage return (0x0d), Line feed (0x0a).
27 ...		Packet(s) here.
last 5	EOF	End of file indication plus Carriage return (0x0d), Line feed (0x0a).

If there are any records to be sent, the first record will automatically be sent after the first command is sent.

Subsequent records must be prompted. This action is a software flow control method. The subsequent record requests are made with the “x” command.

Each record contains binary values (not ASCII). Each record is defined below:

Table 8.27: Binary Retrieve record content

Column	Example value	Description
0	x	Record type. Where bit: 0: 0 = written record, 1 = erased or unwritten record. 4: 0 = initial startup record, 1 = subsequent record taken after waking up from sleep. This bit is only valid for firmware feature ≥ 49 .
1	x	Seconds.
2	x	Minutes.
3	x	Hours.
4	x	Day.
5	x	Date.
6	x	Month.
7	x	Year.
8-11	xxxx	Reading; Big endian raw 32 bit binary value for magnitudes. The decimal reading value is determined as: $Reading_{MPSAS} = \frac{xxxx}{6553600.0}$.
12-13	xx	Temperature; Big endian raw 16 bit value. The decimal temperature value is determined as: $Temperature = \frac{xx \times 33000.0}{1024.0} - 5000.0$
16-19	xxxx	(Optional snow accessory) Standard frequency, Big endian 32 bit value.

Table continued on next page ...

Table 8.27 – *continued from previous page*

Column	Example value	Description
20-23	xxxx	(Optional snow accessory) Snow reading; Big endian raw 32 bit binary value for magnitudes. The decimal reading value is determined as: $Reading_{MPSAS} = \frac{xxxx}{6553600.0}$.
24-27	xxxx	(Optional snow accessory) Snow frequency, Big endian 32 bit value.
28-31	FFFFFFFF $_{hex}$	Spare four bytes.

8.5.8 Get internal voltage

When operating from the external battery to USB connector, the unit is normally supplied 5V. As the external battery voltage drops below 5V (plus the voltage regulator overhead of about 0.1V), the internally supplied unit voltage will drop below 5V. The unit will continue to work while the internal voltage is above 3.3V. This internal voltage can be reported.

To get the internal voltage value, use the “L5x” command. The response is shown in table 8.27:

Table 8.28: Response of requesting internal voltage

Column	Example value	Description
0-2	L5,	Confirmation of command.
3-5	238	Internal voltage ADC value. Internal Voltage = $2.048 + \frac{(3.3 * ADCValue)}{256.0}$
6-7		Carriage return (0x0d), Line feed (0x0a).

An example response is:

```
L5,238
01234567
```

8.5.9 Get EEPROM status register 1

In cases where the erasure of EEPROM memory takes a long time, it is necessary to read the status register busy bit (bit 0) using the “L6x” command. The response is shown in table 8.28:

Table 8.29: Response of requesting EEPROM Status register 1

Column	Example value	Description
0-2	L6,	Confirmation of command.
3-5	000	Integer (value 0-255) representing the status bits as follows: bit 0 : 1 = Busy, 0 = Ready bit 1-7 : Not useful outside the meter. Defined in the data sheet for the Winbond W25Q128FV EEPROM.
last two		Carriage return (0x0d), Line feed (0x0a).

8.5.10 Set and read logging trigger mode

The SQM-LU-DL-V has the following possible modes (see table 8.29) of logging data while the external battery is being used for power:

Table 8.30: Request to set the logging trigger mode

Mode	Description
LM0x	No automatic logging
LM1x	Logging granularity in seconds and not powering down.
LM2x	Logging granularity in minutes and powering down between recordings.
LM3x	Logging every 5 minutes on the 1/12th hour, and powering down between recordings.

Table continued on next page ...

Table 8.30 – continued from previous page

Mode	Description
LM4x	Logging every 10 minutes on the 1/6th hour, and powering down between recordings.
LM5x	Logging every 15 minutes on the 1/4 hour, and powering down between recordings.
LM6x	Logging every 30 minutes on the 1/2 hour, and powering down between recordings.
LM7x	Logging every hour on the hour, and powering down between recordings.

The response of setting the mode is simply an acknowledgement of the trigger mode. Also, reading the mode can be done with “Lmx”, both will produce the response shown in table 8.30:

Table 8.31: Response of setting or getting the log trigger mode

Column	Example value	Description
0-2	LM,	Confirmation of command.
3	0	0 = Off 1 = Seconds 2 = Minutes 3 = Every 5 minutes on the 1/12th hour 4 = Every 10 minutes on the 1/6th hour 5 = Every 15 minutes on the 1/4 hour 6 = Every 30 minutes on the 1/2 hour 7 = Every hour on the hour
4-5		Carriage return (0x0d), Line feed (0x0a).

An example response is:

```
LM,0
012345
```

8.5.11 Logging Interval setting response

Either making the request “LIx” or any request to set the logging interval report setting produces the response shown in table 8.31:

Table 8.32: Response of viewing or setting logging interval reporting parameters

Column	Example value	Description
0-1	LI	Logging interval settings from EEPROM and RAM are being returned.
3-13	0000000360s	Logging interval period in seconds that was set into EEPROM
15-25	0000000005m	Logging interval period in minutes that was set into EEPROM
27-37	0000000121s	Current interval period in seconds from RAM
39-49	0000000004m	Current interval period in minutes from RAM
51-62	00000017.60m	Threshold value that was set into RAM

Table continued on next page ...

Table 8.32 – *continued from previous page*

Column	Example value	Description
63-64		Carriage return (0x0d), Line feed (0x0a).

An example response is:

```
LI,0000000360s,0000000005m,0000000121s,0000000004m,00000017.60m
0123456789 123456789 123456789 123456789 123456789 123456789 1234
```

8.5.12 Logging interval reporting period setting

Executing the command “LPS#####x” sets the period (in seconds) of the timed interval reports to the EEPROM and RAM for booting and immediate use. For example, the command “LPS0000000360x” sets the reporting time to once every 360 seconds.

Executing the command “LPM#####x” sets the period (in minutes) of the timed interval reports to the EEPROM and RAM for booting and immediate use. For example, the command “LPS0000000005x” sets the reporting time to once every 5 minutes.

Use the “LIx” command to read the interval reporting period settings stored in the meter.

8.5.13 Logging threshold setting for interval reporting

Executing the command “LT#####.##x” sets the threshold of the timed interval reports to EEPROM and RAM for boot and immediate use.

The units are $\frac{\text{magnitudes}}{\text{arcsecond}^2}$. For example, LT00000016.00x limits reporting to values only over 16.00 $\frac{\text{magnitudes}}{\text{arcsecond}^2}$.

Use the “LIx” command to read the threshold setting stored in the meter.

8.5.14 Set and read logging Real Time Clock

The SQM-LU-DL model contains a Real Time Clock (RTC) powered by a Supercap (large storage capacitor).

The RTC is set with the “LCx” command as shown in table 8.32:

Table 8.33: Setting the RTC

Column	Example value	Description
0-1	LC	Confirmation of command.
2-21	11-01-06 5 11:51:00x	Date, Day of week (1=Sunday), and time.
22-23		Carriage return (0x0d), Line feed (0x0a).

The RTC is read with the “Lcx” command. The response of both setting and getting the RTC value is shown in table 8.33:

Table 8.34: Response of getting the RTC values

Column	Example value	Description
0-2	LC,	Confirmation of setting command.

Table continued on next page ...

Table 8.34 – *continued from previous page*

Column	Example value	Description
0-2	Lc,	Confirmation of getting command.
3-21	11-01-06 5 11:51:00	Date, Day of week (1=Sunday), and time.
22-23		Carriage return (0x0d), Line feed (0x0a).

An example response is:

```
Lc,11-01-06 5 11:51:00
0123456789 123456789 123
```

8.5.15 Get Real Time Clock version

Original DL model units used the DS1305 Real Time Clock (RTC). Newer units (starting in 2016) used the more accurate DS3234 RTC. The results of getting the RTC version with the “Lv” command is shown in table 8.34:

Table 8.35: Response of getting the RTC version

Column	Example value	Description
0-2	Lv,	Confirmation of command.
3	0	0=Original RTC DS1304 or unknown RTC 1=DS3234 RTC
4-5		Carriage return (0x0d), Line feed (0x0a).

An example response is:

```
Lv,0
012345
```

8.5.16 Put datalogging unit to sleep

For test purposes, the SQM-LU-DL can be put to sleep with the “Lsx” command so that the quiescent battery current can be measured. The unit must be awakened by re-applying power (cold-start).

8.5.17 Gather alarm 0 data from RTC

For tests purposes, the SQM-LU-DL RTC “Alarm 0” data can be retrieved with the “Lax” command. The response is shown in table 8.35:

Table 8.36: Response of getting the RTC “Alarm 0” value

Column	Example value	Description
0-1	La,	Confirmation of command.
3-6	000,	Address 07H, Seconds See “DS1305N”+ RTC chip information for details.
7-10	128,	Address 08H, minutes.
11-14	128,	Address 09H, hours.

Table continued on next page ...

Table 8.36 – *continued from previous page*

Column	Example value	Description
15-18	128,	Address 0AH, day.
19-21	001,	Address 0FH for DS1304, Control register. Address 0EH for DS3324, Control register.
22-23		Carriage return (0x0d), Line feed (0x0a).

An example response is:

```
La,000,128,128,128,001
0123456789 123456789 123
```

8.5.18 Mutual access

Allows the SQM-LU-DL-V to log to its FLASH memory database while connected to a PC as well as while connected to the battery pack.

The default is to only allow triggered logging while connected to the battery pack where there are no data wires (only power wires) connected to the USB jack.

This mutual access settings allows logging while also connected to a PC (when data wires are connected to the USB jack).

The Mutual access mode is set with the “LDnx” command, where n is 0 or 1. The Mutual access mode is read with the “Ldx” command. The response of both setting and getting the mutual access value is shown in table 8.36:

Table 8.37: Response of setting or getting the mutual access mode

Column	Example value	Description
0-2	Ld,	Status mutual access.
3	1	0 = battery only logging is allowed. 1= PC and battery logging is allowed.
4-5		Carriage return (0x0d), Line feed (0x0a).

An example response is:

```
LD,1
012345
```

8.6 Vector commands

The SQM-LU-DL-V uses the Pololu 2127 accelerometer/magnetometer module which contains an STMicroelectronics LSM303D digital 3-axis accelerometer and 3-axis magnetometer module. This module provides vector measurement capabilities of Altitude (inclinometer) and Azimuth (compass) readings.

All of the SQM-LU-DL-V datalogging commands begin with “v” (lower case).

8.6.1 Magnetic readings

To get a report on magnetic values of the accelerometer/magnetometer module use the “v1x” command. The response is shown in table ??:

Table 8.38: Response of requesting the vector module magnetic values

	Position	Example value	Description
0	v1,		Confirmation of command
1	12345,		M_X ; magnetic value of X axis. 5 digits with trailing comma and possible leading negative sign.
2	-12345,		M_Y ; magnetic value of Y axis. 5 digits with trailing comma and possible leading negative sign.
3	00045		M_Z ; magnetic value of Z axis. 5 digits with possible leading negative sign.
			Carriage return (0x0d), Line feed (0x0a).

An example response to “v1x” is:

v1,00005,-00268,-04170

8.6.2 Acceleration readings

To get a report on acceleration values of the accelerometer/magnetometer module use the “v2x” command. The response is shown in table ??:

Table 8.39: Response of requesting the vector module accelerations

	Position	Example value	Description
0	v2,		Confirmation of command
1	12345,		A_X ; acceleration value of X axis. 5 digits with trailing comma and possible leading negative sign.
2	-12345,		A_Y ; acceleration value of Y axis. 5 digits with trailing comma and possible leading negative sign.
3	0045		A_Z ; acceleration value of Z axis. 5 digits with possible leading negative sign.
			Carriage return (0x0d), Line feed (0x0a).

An example response to “v2x” is:

v2,00338,00245,17079

8.6.3 Acceleration calibration values

The acceleration portion of the acceleration/magnetometer module has a set of values when the SQM-LU-DL-V is positioned in the six possible level directions (three axis, each facing upwards and downwards). Calibration is performed by resting the SQM-LU-DL-V on a level surface and recording the three accelerometer readings (A_X, A_Y, A_Z), this step is repeated for each of the 6 possible axis directions. The UDM program can help to gather and record these readings into the SQM-LU-DL-V.

Getting Acceleration calibration values

The format for getting acceleration calibration values is: “v3,p x ” ; where p is a position value between 1-6. See table ?? for the response.

Setting Acceleration calibration values

The format for saving values acceleration calibration values is: “v3,p, 12345,-12345, 12345 x ” ; where p is a position value between 1-6. Characters are position dependent, fields are x, y, z. See table ?? for the response.

Table 8.40: Response of getting or setting the acceleration calibration values

	Position	Example value	Description
0	v3,4,		Confirmation of command. This example shows position 4 from a possible 1-6.
1	␣12345,		AC_X ; acceleration calibration value of X axis at position p . 6 digits with trailing comma. First digit space indicates positive value.
2	-12345,		AC_Y ; acceleration calibration value of Y axis at position p . 6 digits with trailing comma. First digit space indicates positive value.
3	-00045		AC_Z ; acceleration calibration value of Z axis at position p . 6 digits. First digit space indicates positive value.
			Carriage return (0x0d), Line feed (0x0a).

An example response to “v3,1 x ” or “v3,1,-00418, 00193, 17078 x ” is:
v3,1,-00418, 00193, 17078

8.6.4 Magnetic calibration values

The magnetic portion of the acceleration/magnetometer module has a set of values when the SQM-LU-DL-V is facing the strongest flux lines in six possible directions.

Calibration is done by rotating the SQM-LU-DL-V in all directions to obtain maximum positive and maximum negative values on all 3 axis ($\pm M_X, \pm M_Y, \pm M_Z$). The UDM program can be used to record these peak values which can be sent to the SQM-LU-DL-V for permanent storage in its EEPROM.

Getting magnetic calibration values

The command for getting magnetic calibration values is “v4 x ”. See table ?? for the response:

Setting Acceleration calibration values

The command for setting magnetic calibration values is: “v4,... x ” (Ex. `v4,-03102,-03226,-02937, 03502, 03556, 03246 x ”). See table ?? for the response:

Table 8.41: Response of getting or setting the magnetic calibration values

Position	Example value	Description
0	v4,	Confirmation of command.
1	-12345,	M_Xmin ; Minimum magnetic calibration value of X axis. 6 digits with trailing comma. First digit space indicates positive value.
2	-12345,	M_Ymin ; Minimum magnetic calibration value of Y axis. 6 digits with trailing comma. First digit space indicates positive value.
3	-12345,	M_Zmin ; Minimum magnetic calibration value of Z axis. 6 digits with trailing comma. First digit space indicates positive value.
4	␣12345,	M_Xmax ; Maximum magnetic calibration value of X axis. 6 digits with trailing comma. First digit space indicates positive value.
5	␣12345,	M_Ymax ; Maximum magnetic calibration value of Y axis. 6 digits with trailing comma. First digit space indicates positive value.
6	␣12345	M_Zmax ; Maximum magnetic calibration value of Z axis. 6 digits. First digit space indicates positive value.
		Carriage return (0x0d), Line feed (0x0a).

An example response to “v4x” or “v4,-03102,-03226,-02937, 03502, 03556, 03246x” is:
v4,-03102,-03226,-02937, 03502, 03556, 03246

8.6.5 Vibration

Vibration is determined inside the SQM-LU-DL-V by computing the maximum absolute difference of all three acceleration axis over a sampling of the last 4 times each $\frac{1}{60\text{TH}}$ of a second apart.

A vibration report can be produced with the “vvx” request. An example response of the vibration report request is:
vv,00074,00040,00015,00074

8.6.6 Vibration threshold

A method for setting the vibration threshold is provided to prevent light readings from being taken while the SQM-LU-DL-V is being moved around.

Getting vibration threshold value

The vibration threshold can be retrieved with the “vtx” request. An example response to the vibration threshold request is:

vt, 00500

Setting vibration threshold value

The vibration threshold can be set with the “vT, nnnnnx” request. An example request is:

vT, 00500x

The response to that request is:

vT, 00500

8.7 Accessories commands

Some I²C accessory devices can be connected to the SQM-LU-DL-V when using firmware feature version 44 and above. These devices are connected by way of retrofitted wiring inside the unit or a future back panel connector.

All of the SQM-LU-DL-V accessory commands begin with “A” (upper case).

8.7.1 Humidity / Temperature sensor

Two I²C humidity/temperature sensors models can be connected to the SQM-LU-DL-V. All commands (seen in table 8.37) to this accessory result in a response (seen in table 8.38).

Table 8.42: Humidity/temperature command summary

Command	Description
A1Ex	Enable the humidity temperature accessory.
A1Dx	Disable the humidity temperature accessory.
A1Mmx	Set the model number (where $m=0-7$) of the the humidity temperature accessory: 0=HIH8120 1=HYT939 (Sold by ControlEverything and others)
A1x	Report on the humidity temperature status.

Table 8.43: Humidity/temperature response summary

Position	Example value	Description
0	A, 1,	Confirmation of humidity/temperature accessory command.
1	1,	Accessory 1 (Humidity/temperature sensor).
2	e,	E for enabled. D for disabled.
3	m,	Model number (where $m=0-7$): 0=HIH8120 1=HYT939 (Sold by ControlEverything and others)
4	s	Status (0-3). 0 = Normal Operation, Valid Data that has not been fetched since the last measurement cycle. 1 = Stale Data: Data that has already been fetched since the last measurement cycle, or data fetched before the first measurement has been completed. 2 = Sensor in Command Mode. 3 = Not used.
5	nnnnn	Humidity(%RH) = $\frac{nnnnn}{2^{14}-2} \times 100\%$. 16383 when no connection.
6	nnnnn	Temperature(°C) = $\frac{nnnnn}{2^{14}-2} \times 165 - 40$. 16383 when no connection.
	c r f	Carriage return (0x0d), Line feed (0x0a).

An example response to “A1x” is:

**A,1,E,1,0,07788,06202c
r
f**

8.7.2 Display accessory

An I²C 4-digit 7-segment display made by Sparkfun (model COM-11441) can be connected. All commands (seen in table 8.39) to this accessory result in a response (seen in table 8.40).

Readings that are too bright for the SQM-LU-DL-V will show up as □ □ □ □ . Readings that are too dark for the meter will show up as □ □ □ □ .

Table 8.44: Display accessory command summary

Command	Description
A2Ex	Enable the display accessory.
A2Dx	Disable the display accessory.
A2Fx	Fixed mode of brightness.
A2Ax	Auto mode of brightness. Lowers brightness on dark nights. Display at lowest brightness (30%) when greater than 19.00mpsas. Display at medium brightness (50%) between 17.00 to 19.00mpsas. Display at full brightness (100%) when less than 17.00mpsas.
A2Mnx	Set the model of display (where $n = 0-3$).
A2Vnx	Set the fixed mode brightness (where $n = 0-7$).
A2Px	Set the updating mode to periodically updating at 1Hz.
A2Rx	Set the updating mode to updating when reading request is made.
A2x	Report on the display status.

Table 8.45: Display accessory response summary

Position	Example value	Description
0	A,	Confirmation of display accessory command.
1	2,	Accessory 2 (Display).
2	e,	E for enabled. D for disabled.
3	m,	Model number (where $m = 0-3$).
4	m,	F=Fixed mode. A=Auto mode. See table 8.39 for description.
5	n,	Fixed brightness level (where $n = 0-7$).
6	m	P = periodically updating at 1Hz R = updating when reading request is made.
	c L R F	Carriage return (0x0d), Line feed (0x0a).

An example response to “A2x” is:

A,2,E,0,F,2,R_cL_RF

8.7.3 LED accessory

The LED at the back of the SQM-LU-DL-V is used for this built-in accessory. All commands (seen in table 8.41) to this accessory result in a response (seen in table 8.42).

Using the LED to indicate when a reading is being requested is an ideal method to determine if the controlling software is actually accessing the SQM-LU-DL-V.

Table 8.46: LED accessory command summary

Command	Description
A3Ex	Enable the LED accessory.
A3Dx	Disable the LED accessory.
A30x	Mode=Blink at reading creation. In bright sky conditions, readings are created once per second in frequency-mode. In darker sky conditions, the meter goes into period-mode starting at 679Hz and lower, and LED will blink at a variable rate.
A31x	Mode=Blink at reading request.
A3x	LED accessory status.

Table 8.47: LED accessory response summary

Position	Example value	Description
0	A,	Confirmation of display accessory command.
1	3,	Accessory 3 (LED).
2	e,	E for enabled. D for disabled.
3	m,	Model number (where $m = 0-7$). 0 = LED connected to pin-13 through 1k resistor to ground.
4	m,	Mode of operation (where $m = 0-1$): 0 = Blink at reading creation. 1 = Blink at reading request.
	$\begin{matrix} \text{C} \\ \text{L} \\ \text{R} \\ \text{F} \end{matrix}$	Carriage return (0x0d), Line feed (0x0a).

An example response to “A2x” is:

A,3,E,0,1 $\begin{matrix} \text{C} \\ \text{L} \\ \text{R} \\ \text{F} \end{matrix}$

8.7.4 Relay accessory

A Solid State Relay (SSR) accessory may be connected to the SQM-LU-DL-V for generic use or for purposes of implementing a dew-heater control. All commands (seen in table 8.43) to this accessory result in a response (seen in table 8.44).

Table 8.48: Relay accessory command summary

Command	Description
A4x	Get status of the relay accessory.
A40x	Deactivate the relay accessory. Also places the accessory into manual mode.
A41x	Activate the relay accessory. Also places the accessory into manual mode.
A4Mnx	Set the mode of operation: 0=Light threshold activated. 1=Dewpoint activation. 2=Heat activated. 3-6=future use. 7=Manual mode where only the A40x and A41x commands affect the relay activation.
A4Tnnx	Set the darkness threshold for relay activation. Where <i>nn</i> is the the darkness threshold. The relay will be activated above this threshold. Monitoring is performed once per second.

Table 8.49: Relay accessory response summary

Position	Example value	Description
0	A,	Confirmation of display accessory command.
1	4,	Accessory 3 (relay).
2	s,	Status of device: 0 for deactivated relay. 1 for activated relay.
3	m,	Mode of operation (where <i>m</i> =0-7): 0 = Light mode. 1 = Dewpoint mode. 2 = Heat mode. 7 = Manual mode.
4	nn	Threshold of darkness (in mpsas) for automatic mode of operation.
5	ttt	Temperature (°C) used for dewpoint calculation.
6	hhh	Humidity (%RH) used for dewpoint calculation.
7	ddd	Dewpoint temperature (°C) used for dewpoint calculation.
	c r f	Carriage return (0x0d), Line feed (0x0a).

An example response to “A2x” is:

**A,4,1,2,15,10,50,40,0c
r
f**

8.8 Continuous reporting commands

The Continuous reporting features are somewhat experimental. A description of each feature follows:

Table 8.50: Summary of standard commands

Option	Description
Reporting enabled	Send a reading result every time it is available from internal computations. In bright settings, a reading will be made available once per second, around 14mpsas, a reading will be available depending on the sensor response which is between 60+ times per second and 60 seconds in very dark settings.
Ideal crossover firmware	Changes the crossover of reporting from original (around 15mpsas to 12.32mpsas which results in better resolution across the entire range of possible readings.
Reporting compressed	Send the above enabled reading out in a compressed format without extra text.
Report un-averaged	Sends the above reading out from the un-averaged accumulator. Normally the averaged reading is sent.

Table 8.51: Continuous reporting command summary

Command	Description
Yx	Get status of the continuous reporting features.
YRx	Enable continuous reporting.
Yrx	Disable continuous reporting.
YCx	Enable ideal crossover firmware code.
Ycx	Disable ideal crossover firmware code.
YPx	Enable continuous reporting compression.
Ypx	Disable continuous reporting compression.
YUx	Enable un-averaged continuous reporting.
Yux	Disable un-averaged continuous reporting.

Table 8.52: Response of all continuous reporting requests

Column	Example value	Description
0	Y	Confirmation of command.
1	r	R = Continuous reporting enabled. r = Continuous reporting disabled.
2	C	C = Ideal crossover firmware code enabled. c = Ideal crossover firmware code disabled.
3	p	P = Continuous reporting compression enabled. p = Continuous reporting compression disabled.
4	u	U = Continuous reporting un-averaged readings enabled. u = Continuous reporting un-averaged readings disabled.

Table continued on next page ...

Table 8.52 – *continued from previous page*

Column	Example value	Description
5-6	$\overset{\text{C}}{\underset{\text{R}}{\text{L}}}\overset{\text{L}}{\text{F}}$	Carriage return (0x0d), Line feed (0x0a).

An example response is:

YrCpu $\overset{\text{C}}{\underset{\text{R}}{\text{L}}}\overset{\text{L}}{\text{F}}$
0123456

8.9 Setting Interval reporting parameters

For firmware feature ≥ 13 , the SQM-LU-DL-V is capable of sending timed interval reports. Each interval report is the same as the reading request report except that the serial number (feature ≥ 14) is attached at the end so that numerous reporting SQM-LU-DL-Vs can be distinguished from each other.

The format of the interval report is shown in table 8.48:

Table 8.53: Interval report

Column	Example value	Description
0	r	Indicates that a reading is being returned.
2-8	_06.70m	Reading in magnitudes per square arc second. Leading space for positive value. Leading negative sign (-) for negative value. A reading of 0.00m means that the light at the sensor has reached the upper brightness limit of the unit.
10-21	0000022921Hz	Frequency of sensor in Hz.
23-33	0000000020c	Period of sensor in counts. Counts occur at a rate of 460.8 kHz (14.7456MHz/32).
35-46	0000000.000s	Period of sensor in seconds with millisecond resolution. Determined by dividing the above counts value by 460800.
48-54	_039.4C	Temperature measured at light sensor in degrees C. The value is averaged and presented every 4.3 seconds. Leading space for positive value. Leading negative sign (-) for negative value.
55-63	00000413	Serial number (8 digits). Each unit has its own unique serial number.
64-65	$\begin{smallmatrix} \text{C} \\ \text{R} \end{smallmatrix}$	Carriage return (0x0d), Line feed (0x0a).

An example is:

```
r, 06.70m,0000022921Hz,0000000020c,0000000.000s, 039.4C,00000413 $\begin{smallmatrix} \text{C} \\ \text{R} \end{smallmatrix}$ 
0123456789 123456789 123456789 123456789 123456789 123456789 123456789 123456789
```

8.9.1 Interval reporting period setting

Executing the command “P#####x” (note upper case “P”) sets the period of the timed interval reports to the EEPROM and RAM for booting and immediate use.

Executing the command “p#####x” (note lower case “p”) sets the period of the timed interval reports to RAM only for immediate use.

The units are seconds. For example, the command “p0000000360x” sets the reporting time to once every 360 seconds.

8.9.2 Threshold setting for interval reporting

Executing the command “T#####.##x” (note upper case “T”) sets the threshold of the timed interval reports to EEPROM and RAM for boot and immediate use.

Executing the command “t#####.##x” (note lower case “t”) sets the threshold of the timed interval reports to RAM for immediate use only.

The units are $\frac{\text{magnitudes}}{\text{arcsecond}^2}$. For example, t00000016.00x limits reporting to values only over 16.00 $\frac{\text{magnitudes}}{\text{arcsecond}^2}$

8.9.3 Interval setting response

Either making the request “Ix” (note upper case “I”) or any request to set the interval report setting produces the following response shown in table 8.49:

Table 8.54: Response of viewing or setting interval reporting parameters

	Column	Example value	Description
0	I		Interval settings from EEPROM and RAM are being returned.
2-12		0000000360s	Interval period that was set into EEPROM.
14-24		0000300360s	Interval period that was set into RAM.
26-37		00000017.60m	Threshold value that was set into EEPROM.
39-50		00000017.60m	Threshold value that was set into RAM.
51-52	C R F		Carriage return (0x0d), Line feed (0x0a).

An example response is:

```
I,0000000360s,0000000360s,00000017.60m,00000017.60mC  
0123456789 123456789 123456789 123456789 123456789 12
```

8.10 Simulation commands

The following simulation commands help to determine the results of $\frac{mag}{arcsec^2}$ readings derived from the light and temperature sensors.

When using the Simulation mode of the SQM-LU-DL-V, make sure that nothing else interrupts the sequence of readings such as external programs reading from the SQM-LU-DL-V, or settings of Interval reporting inside the SQM-LU-DL-V. To read the internal simulation values, issue the **Sx** command, the response is shown in table 8.50:

Table 8.55: Response of request for internal simulation values

Column	Example value	Description
0	s	Confirmation of the command.
1	,	Separation character.
2-12	0000000360c	Number of counts.
13	,	Separation character.
14-24	0000000360f	Frequency in Hz.
25	,	Separation character.
26-37	0000000244t	Temperature ADC value as seen by the CPU. See Equation 8.1 .
38-39	␣␣	Carriage return (0x0d), Line feed (0x0a).

An example response is:

```
s,0000000360c,0000000360f,0000000360t␣␣  
0123456789 123456789 123456789 12345678
```

To convert raw temperature value to degrees C:

$$DegC = \frac{\frac{raw \times 3.3}{1024} - 0.5}{0.01} \quad (8.1)$$

To convert degrees C value to raw temperature:

$$raw = \frac{(DegC \times 0.01 + 0.5) \times 1024}{3.3} \quad (8.2)$$

To set the internal simulation values and read the calculated response, issue the **S...x** command as detailed in Table 8.51. The result of that command is shown in Table 8.52.

Table 8.56: Request simulation (S...x)

Column	Example value	Description
0-1	S,	Initiation of Sx command.
2-11	0000000360	Simulated counts.
12	,	Separation character (can be anything except x).
13-22	0000000360	Simulated Frequency in Hz
23	,	Separation character (can be anything except x).

Table continued on next page ...

Table 8.56 – *continued from previous page*

Column	Example value	Description
24-33	00244	Simulated Temperature ADC value. See Equation 8.1 .
34	x	Terminating character.
35-36	$\overset{\text{C}}{\underset{\text{R}}{\text{F}}}$	Carriage return (0x0d), Line feed (0x0a).

An example command is:

S,0000000360,0000000360,0000000360x $\overset{\text{C}}{\underset{\text{R}}{\text{F}}}$
 0123456789 123456789 123456789 123456

Table 8.57: Response of setting simulation values (S...x)

Column	Example value	Description
0-1	S,	Confirmation of S...x command.
2-13	0000094000c,	Simulated counts.
14-25	0000000000f,	Simulated frequency in Hz.
26-37	0000000245t,	Simulated temperature ADC value. See Equation 8.1 .
38-39	r,	Beginning of calculated readings.
40-47	_18.04m,	Calculated $\frac{mag}{arcsec^2}$.
48-60	0000000000Hz,	Frequency used for calculation.
61-72	0000094000c,	Counts used for calculation.
73-85	0000000.204s,	Calculated period from counts.
86-92	_029.0C	Temperature used for calculation.
93-94	$\overset{\text{C}}{\underset{\text{R}}{\text{F}}}$	Carriage return (0x0d), Line feed (0x0a).

An example response is:

S,0000094000c,0000000000f,0000000245t,r, 18.04m,0000000000Hz,0000094000c,0000000.204s, 029.0C $\overset{\text{C}}{\underset{\text{R}}{\text{F}}}$
 0123456789 123456789 123456789 123456789 123456789 123456789 123456789 123456789 1234

9 Installation

The SQM-LU-DL-V uses an internal voltage-regulator to bring the incoming USB 5VDC voltage from the PC down to 3.3VDC. The 5V USB voltage is measured and logged during data-logging operation.

The battery adapter uses an in-line-mounted voltage-regulator to bring the 9VDC down to 5VDC.

9.1 Mechanical installation

Unihedron sells an enclosure that is suitable for mounting either the SQM-LE, SQM-LU, SQM-LR, SQM-LU-DL into. You can read more about it, including plans to build your own at www.unihedron.com/projects/sqmhousing/.



Figure 9.1: Housing

9.1.1 Cover selection

If the unit is to be mounted in exposed location, we recommend the UniHedron plastic weatherproof housing with glass window plate, or an acrylic dome. Acrylic domes will last 2-3 years but eventually weather on the surface. It is not clear that this will affect the reading much. The best test would be to swap a weathered and new one back and forth when changing one out. Presumably the main consideration would be to keep the domes clean every so often and to make sure that the mounting plane is painted black to that it doesn't reflect light back to the inside of the dome and then back into the meter.

Source of acrylic domes: www.globalplastics.ca/domes.htm

9.1.2 Cover calibration

Since the meter is not weather-proof, it must be protected in some way from the elements. The UniHedron meter housing or a plastic dome is recommended. This will reduce the incoming light (approximately 15-20%).

Because a covering will reduce the incoming light, the resultant reading will be darker (higher $\frac{mag}{arcsec^2}$ value). The offset determined by a simple light experiment should be subtracted from the reading.

The light calibration offset is like a starting point for readings, and since the cover glass makes readings darker, the offset should compensate by starting a brighter value.

Apply the cover subtraction offset as a negative value, i.e. if you measured 16.60 outside the covering, then 16.75 under the dome, then an offset of -0.15 should be applied to all readings.

An example using the UDM software; if your offset is -0.15 and your factory calibrated light calibration offset is 19.92 then you should change the light-calibration-offset on the calibration-tab to 19.77. European users will see and use a comma instead of a decimal point (eg. 19,77).

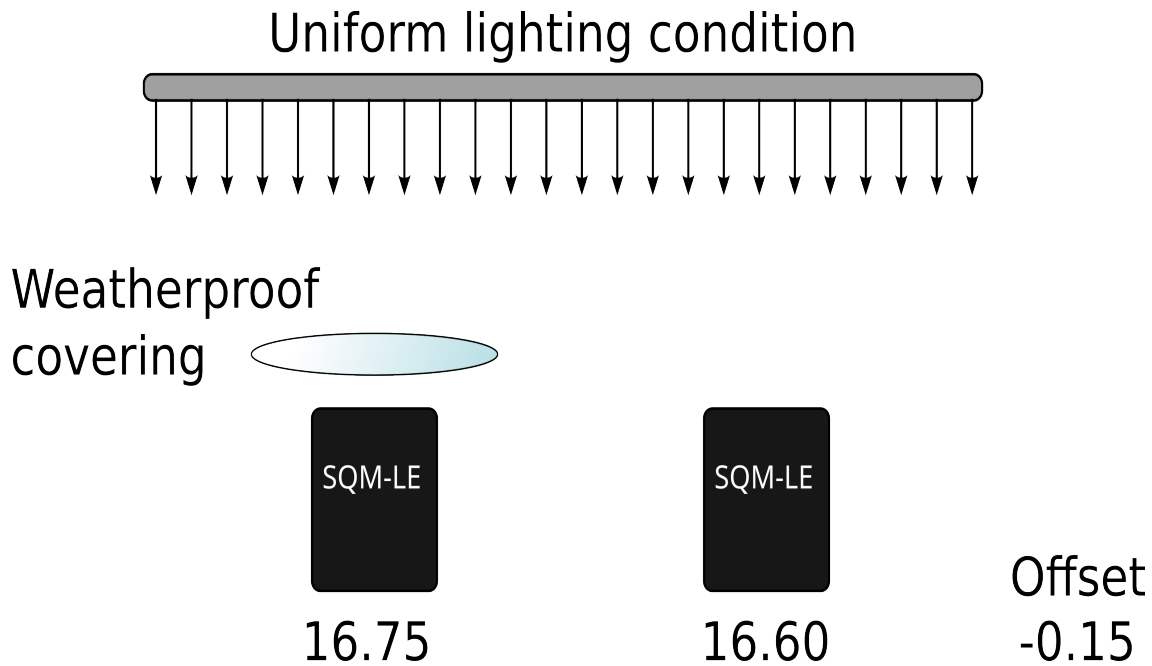

Figure 9.2: Example cover calibration

9.1.3 Cover maintenance

Keep the covering clean of dust, water, ice, and bird droppings.

10 Default settings

The SQM-LU-DL-V contains an FTDI USB interface module.

The FTDI interface has not been altered from its default. There should be no reason to alter the FTDI chip settings. The baud rate is defined by the VCP driver side when a terminal program connects to the SQM-LU-DL-V.

11 Firmware upgrade

See the UDM “Firmware tab” section on page 62 for instructions on updating the firmware in the SQM-LU-DL-V.

11.1 Details

The SQM-LU-DL-V contains a micro-controller that is equipped with a boot-loader mechanism which is enabled for a few seconds after reboot/reset.

Intel hex strings sent to the unit are used to overwrite program memory. The following link contains a thorough description of the Intel Hex format: <http://en.wikipedia.org/wiki/.hex>

The basic requirements for firmware uploading are:

1. Reset micro-controller by sending the hex character 0x19
2. Within a few seconds, send the first Intel hex record. The colon “:” character indicates the beginning of an Intel Hex record.
3. Wait for a response of “Ok” followed by “CR LF” which indicates that the record was processed properly.
4. Continue sending records and waiting for the acknowledgement.
5. The unit will reset on its own when no more records have been sent for a few seconds.

12 Calibration

The SQM-LU-DL-V is factory calibrated and a sheet of the calibration values was provided with the unit. Contact Unihedron with your unit's USB S/N if you need a copy of the original calibration sheet.

Some possible reasons for recalibration are:

1. A new covering/housing is being used besides the small case that the unit was shipped with.
2. A regular maintenance program is desired. There is no great need for this as the SQM-LU-DL-V has no analog components.
3. Compensation for aged housing, if a plastic dome is used that might have degraded over time.
4. Replaced lens or changed field of view for experimental reasons.

12.1 Recalibration

There is no easy way to perform in-field recalibration. It is recommended to send the unit back to Unihedron for proper calibration. There is a nominal fee for recalibration and shipping. Please contact Unihedron for details.

12.2 Light calibration

The sensor must have a reference point for an amount of light against the signal produced. It is not recommended that this be done after factory calibration and relied upon since an improper setup will result in non-standard results.

A fluorescent light or green LED is used to simulate the spectrum that the meter would see during the night sky. A light meter is used to adjust the light reading to 13.5 fc at the place of the SQM-LU-DL-V. The light calibration routine inside the SQM-LU-DL-V expects to see this value.

The light that the SQM-LU-DL-V and light meter see must be coming from an evenly lit surface.

The "light calibration" command can be sent to the unlocked SQM-LU-DL-V to set the calibration value.

12.3 Dark calibration

The optical sensor in the SQM-LU-DL-V produces a reading even when totally dark. This "dark level" reading must be determined so that the meter can compensate for it.

The method of dark calibration is simply to prevent any light from entering the meter then execute a "dark calibration" command to the unit. A darkroom bag is one way to prevent light from entering the unit.

The optical sensor provides timed pulses depending on the amount of light entering. In a dark environment the pulses will be long. The meter has a timeout of 300 seconds, so the dark calibration will take at least 5 minutes (300 seconds) to perform.

Place the unit in a dark environment and monitor the timed readings (rx reading request) until they are consistent, normally the value is in the 80-300 second range, then execute the "dark calibration" command.

12.4 Confirmation

Once the calibration has been done, you should be able to get a light reading from the unit at the calibration light level of the same value as the value printed on your calibration sheet in the "Calibration offset" field, Normally this field has a value of 8.71 mags/arcsec².

12.5 Altitude and Azimuth calibration

See section ?? on page ?? for details on calibrating the Altitude and Azimuth module.

13 Troubleshooting

Table 13.1: Reading seem too bright

Problem	The meter reads values that are brighter than expected.
Cause	A light may be shining into the field of view of the meter. Or, the IR filter may have fallen out of the lens.
Solution	Ensure that there are no extra sources of visible light in the field of view of the meter. Also, some infrared security cameras emit enough light in the spectrum that the meter will pick up. Inspect lens for IR filter. You should see a light blue colour inside the lens.

Table 13.2: Reading is 0.00mpsas

Problem	The meter reads values of 0mpsas.
Cause	In bright light over about 6mpsas (even indoors) the meter saturates and will produce a reading of 0mpsas.
Solution	Test the meter in a darker setting or place a cover over the meter while doing indoor testing. Note: in complete darkness (like a photo-darkroom), the meter may timeout and also produce strange readings.

Table 13.3: Cannot Find UDM software

Problem	Microsoft Edge cannot find UDM software on the CD. Error “Can’t reach this page”.
Cause	Microsoft Edge has protections in place to hide file lists on remote drives.
Solution	Use the File Manager to navigate the CD to the Windows directory then install from there. Or, get the latest Windows version of UDM from the Unihedron website: unihedron.com/projects/darksky/cd/Windows/

Table 13.4: Driver not found

Problem	USB driver not found
Cause	Some operating systems may not have the FTDI VCP USB driver installed by default.
Solution	You can get the most updated driver for your operating system from FTDIchip.com here: http://ftdichip.com/Drivers/VCP.htm

Table 13.5: USB device not found, or more than one device on the same COM port

Problem	USB device not found, or more than one device on the same COM port
Cause	Faulty USB software driver, or faulty USB hardware port on computer
Solution	<ul style="list-style-type: none"> • Try the meter on another USB port on the computer. Sometimes certain USB ports do not work for various software or hardware reasons. • Ensure that the latest FTDI USB VCP driver is installed, you can check the version number from FTDIchip.com here: http://ftdichip.com/Drivers/VCP.htm • Use the UDM software to identify found devices. The SQM-LU-DL-V device has a serial number prefix of FT..... This may help identify what the other device is. • Remove any other USB devices attached to the system to troubleshoot this problem. • Try to reassign the SQM-LU-DL-V to another COM port using the Windows Device Manager. For example, if the SQM-LU-DL-V is assigned to COM1, then try to assign it to a free COM port number.

Table 13.6: USB serial number garbled

Problem	USB serial number garbled in the UDM found devices box on Windows. The serial number should look something like this: FTESKYBA a garbled serial number looks something like this: 5&dc4a97
Cause	Non FTDI device driver installed on Windows
Solution	Visit the FTDI website to download and install the latest FTDI VCP USB device driver: https://ftdichip.com/drivers/vcp-drivers/ Note that installing device drivers may affect the way other USB devices are recognized on your computer. If you don't mind having a garbled serial number show up in the UDM found devices box, then just leave the device drivers alone.

Table 13.7: LED does not light up

Problem	LED does not come on initially when battery pack is connected
Cause	Sometimes the battery contacts become oxidized which prevents the proper voltage from reaching the meter.
Solution	Clean the battery contacts by rolling the batteries with your thumb while they are in the holder. This will scrape off the oxide buildup.

Table 13.8: Recording stops

Problem	The meter stops recording while connected to the computer
---------	---

Table continued on next page ...

Table 13.8 – continued from previous page

Cause	Some computers, especially laptops, have the “USB suspend mode” activated which puts the USB port to sleep when there is not enough activity on the computer.
Solution	<p>The USB sleep issue can be corrected by ensuring that your power settings do not put the USB ports to sleep when the computer is inactive. This can be true for any operating system. In Windows, the Windows Control panel procedure to disable the USB suspend setting is located here:</p> <p>Start Control Panel Hardware and Sound Power Options Edit Power Plan Settings Put the computer to sleep while plugged in = Never Change advanced power settings USB Settings USB selective suspend setting Plugged in = Disabled OK Save changes</p>

Table 13.9: Meter cannot be found on battery or by PC

Problem	Meter cannot be found, or stops working intermittently when connected to battery or computer.
Cause	Faulty FTDI USB module inside meter.
Solution	<p>There is not much that can be done to correct this aside from replacement. However, the following test usually reliably proves the issue. While connected to the computer using UDM, run the unit in “Log continuous” mode at 1 second sampling for at least 1000 samples. If there are any missed readings, the “records missed” counter on the screen will increment and show Red. The test procedure is as follows:</p> <ol style="list-style-type: none"> 1. Start UDM and select the device. 2. Press the “Reading” button to test connectivity. 3. Press the “Log continuous” button. 4. Select “Every x seconds”. 5. Enter 1 into the s box to the right of the selection. 6. Press “Record”. 7. Let this run for at least 1000 records and watch that are no “Records missed”.

Table 13.10: UDM improperly lists devices under Windows OS

Problem	UDM improperly lists devices under the Windows operating system as duplicates COM ports.
Cause	The registry entries for the FTDI driver COM port assignments may be messed up.

Table continued on next page ...

Table 13.10 – *continued from previous page*

Solution	<p>The following steps can be used to clean up the COM port entries in Windows:</p> <ol style="list-style-type: none"> 1. Unplug all FTDI devices. 2. In the Windows device manager, tag "show hidden devices". 3. Delete the COM ports, but keep the driver. 4. Re-connect one FTDI device after the other.
----------	--

Table 13.11: Meter cannot be found by Windows operating system

Problem	The windows computer cannot identify the SQM-LU-DL-V, and re-installing the FTDI device drivers does not help.
Cause	The Windows FTDI driver installation may be storing old attempts at installing drivers that should have been cleared out.
Solution	<p>The following steps can be used to clean up the FTDI entries in Windows:</p> <ol style="list-style-type: none"> 1. Install this FTDI "CDM Uninstaller" utility at: www.ftdichip.com/Support/Utilities/CDMUninstaller_v1.4.zip 2. The detailed instructions for its operation are here: www.ftdichip.com/Support/Utilities/CDM_Uninst_GUI_Readme.html 3. Here is a quick summary of the instructions: 4. Start up the CDM uninstaller program 5. Press - Add 6. Press - Remove devices 7. Wait 5 minutes or so until complete 8. Close 9. Re-insert SQM-LU device 10. Wait 5 minutes or so for Windows to install driver and port

Table 13.12: Cannot get a reading

Problem	Cannot get a reading
Cause	Driver is not installed or the SQM-LU-DL-V is not connected

Table continued on next page ...

Table 13.12 – continued from previous page

Solution	<p>For Windows, check that the unit is registered using the registry editor from the Start menu, select Run, then type in <code>regedit</code> and press OK.</p> <p>For Windows XP and Windows 2000, look here for your device</p> <pre>HKEY_LOCAL_MACHINE\ SYSTEM\ Enum\ FTDIBUS\ VID_0403+PID_6001+Serial_Number\ 0000\ PortName</pre> <p>For Windows 98 and Windows ME, look here for your device</p> <pre>HKEY_LOCAL_MACHINE\ SYSTEM\ Enum\ FTDIBUS\ VID_0403+PID_6001+Serial_Number\ 0000\ PortName</pre> <p>The <i>Serial_Number</i> is printed on the bottom of the unit.</p> <p>The above will identify which COM port the SQM-LU-DL-V has been assigned.</p> <p>If the SQM-LU-DL-V is plugged in, the active COM port will show up in this list:</p> <pre>HK_LOCAL_MACHINE\ HARDWARE\ DEVICEMAP\ SERIALCOMM</pre> <p>For Linux and Mac, use <code>lshal</code> to determine which device the FTDI driver has attached the SQM-LU-DL-V to. The CD contains a Perl script <code>findftdi.pl</code> to filter out the lshal output.</p>
----------	---

Table 13.13: Darkroom-bag readings incorrect

Problem	Meter readings from inside a darkroom-bag are not dark enough or do not change.
Cause	In completely dark environments, the meter cannot collect enough light to even resolve one reading.
Solution	Test the meter in <u>natural darkness outside at night.</u>

Table 13.14: UDM shuts down after starting

Problem	UDM shuts down after starting
Cause	An improper startup option may be stored.
Solution	Remove the [Startup options] section from the config file using a text editor. Mac and Linux stores the configuration in <code>udm.cfg</code> , Windows stores the configuration in <code>udm.ini</code> . See 7.3

14 Glossary

Table 14.1: Glossary of terms

ADC	A nalog to D igital C onverter. A device used to convert an analog signal into a digital value.
CCD	C harge coupled d evice is a type of image sensor.
EEPROM	E lectrically E rasable P rogrammable R ead O nly M emory is a type of memory that retains its contents after the power has been removed. This type of memory has a limited write/erase cycle as well as a lifetime for data retention. In the SQM-LU-DL-V, the parameters in the micro-controller can be written 1 million times and last for 100 years.
Firmware	The program that resides inside the device. In the case of the Unihedron SQM products, it is the software that runs the device including reading and reporting the light values.
FITS	F lexible I mage T ransport S ystem is an open standard defining a digital file format useful for storage, transmission and processing of scientific and other images.
FTDI	F uture T echnology D evelopments I nternational is the manufacturer of the USB module inside the SQM-LU-DL-V. FTDI also supplies the VCP software driver for the computer operating system so that the SQM-LU-DL-V can communicate with the computer.
GPS	G lobal P ositioning S ystem. A GPS receiver may be connected to a computer to allow UDM to integrate the location information into the logged data. See UDM for mode details.
mpsas	M agnitudes p er s quare a rcsecond. The unit of measurement reported by the SQM.
NMEA	N ational M arine E lectronics A ssociation data format that the GPS receiver produces.
RAM	R andom A ccess M emory. Temporary memory that only retains data while power is applied.
RTC	R eal T ime C lock. A circuit that is used to keep “real time” data like date/time. Computations for leap year and weekday are performed in this circuit.
SQM-LU-DL-V	S ky Q uality M eter with L ens and U SB connectivity, and with d atalogging capabilities, and with the V etcor measurements Altitude (inclinometer) and Azimuth (compass).
Supercap	A very large capacitor in the order of Farads. The SQM-LU-DL-V uses a supercap to keep the RTC running when the meter is not connected to any external power supply. The advantage of this component is that no internal battery must be regularly replaced. The disadvantage is that the capacitor must be occasionally charged up before using the meter for external battery assisted datalogging. When fully charged (a few hours), the capacitor will last for weeks.
UDM	U nihedron D evice M anager is software used to access the SQM series of meters.
USB	U niversal S erial B us
UTC	C oordinated U niversal T ime is the primary time standard by which the world regulates clocks and time.
VCP	V irtual C OM p ort (V CP) drivers cause the USB device to appear as an additional COM port available to the PC. Application software can access the USB device in the same way as it would access a standard COM port. The SQM-LU-DL-V requires the FTDI VCP driver be installed on the computer operating system so that communications can be done with the meter.

15 Bibliography

- [1] Christopher Kyba, etc., *Worldwide variations in artificial skyglow*. PNAS, Volume 1, Issue 6, 2014. <https://www.nature.com/articles/srep08409>
- [2] Wikipedia, *Apparent Magnitudes of Known Celestial Objects*. http://en.wikipedia.org/wiki/Apparent_magnitude
- [3] Schaefer, B.E. Feb. 1990. Telescopic Limiting Magnitude. PASP 102:212-229 http://adsbit.harvard.edu/cgi-bin/nph-iarticle_query?bibcode=1990PASP..102..212S
- [4] Olof Carlin, Nils. About Bradley E. Schaefer, Telescopic limiting Magnitudes, Web page discussion of brightness in Schaefer (1990) and Clark (1994). <http://w1.411.telia.com/~u41105032/visual/Schaefer.htm>(accessed7/2003)
- [5] NELM Converter, K. Fisher fisherka@csolutions.net Rev. 8/2006 <http://unihedron.com/projects/doug/darksky/NELM2BCalc.html>
- [6] Moon Phase Pascal code in UDM is from the public domain library: Moon.pas Copyright 1997-2001 Andreas Hörste-meier Version 2.0 2001-07-07 Algorithms taken from the book "Astronomical Algorithms" by Jean Meeus

Company information

Mailing address	Unihedron 4 Lawrence Avenue Grimsby, Ontario L3M 2L9 Canada
Telephone	(905) 945-1197
Website	unihedron.com